



CALL NO. 303

CONTRACT ID. 185007

JEFFERSON COUNTY

FED/STATE PROJECT NUMBER FD04 056 3396 C00033N

DESCRIPTION PARK BOUNDARY ROAD (CS 3396)

WORK TYPE BRIDGE REPAIRS

PRIMARY COMPLETION DATE 4/15/2019

LETTING DATE: October 26,2018

Sealed Bids will be received electronically through the Bid Express bidding service until 10:00 AM EASTERN DAYLIGHT TIME October 26,2018. Bids will be publicly announced at 10:00 AM EASTERN DAYLIGHT TIME.

NO PLANS ASSOCIATED WITH THIS PROJECT.

REQUIRED BID PROPOSAL GUARANTY: Not less than 5% of the total bid.

TABLE OF CONTENTS

PART I	SCOPE OF WORK
	<ul style="list-style-type: none">• PROJECT(S), COMPLETION DATE(S), & LIQUIDATED DAMAGES• CONTRACT NOTES• STATE CONTRACT NOTES• EXPEDITE WORK ORDER• SPECIAL NOTE(S) APPLICABLE TO PROJECT• BRIDGE DEMOLITION, RENOVATION• ASBESTOS ABATEMENT REPORT• RIGHT OF WAY NOTES• UTILITY IMPACT & RAIL CERTIFICATION NOTES• DEPT OF ARMY - NATIONWIDE PERMIT
PART II	SPECIFICATIONS AND STANDARD DRAWINGS
	<ul style="list-style-type: none">• SPECIFICATIONS REFERENCE• SUPPLEMENTAL SPECIFICATION
PART III	EMPLOYMENT, WAGE AND RECORD REQUIREMENTS
	<ul style="list-style-type: none">• LABOR AND WAGE REQUIREMENTS• EXECUTIVE BRANCH CODE OF ETHICS• KENTUCKY EQUAL EMPLOYMENT OPPORTUNITY ACT OF 1978 LOCALITY / STATE• PROJECT WAGE RATES / STATE
PART IV	INSURANCE
PART V	BID ITEMS

PART I
SCOPE OF WORK

ADMINISTRATIVE DISTRICT - 05

CONTRACT ID - 185007

FD04 056 3396 C00033N

COUNTY - JEFFERSON

PCN - DE05633961807

FD04 056 3396 C00033N

PARK BOUNDARY ROAD (CS 3396) (MP 0.010) ADDRESS DEFICIENCIES OF PARK BOUNDARY ROAD BRIDGE OVER MID FORK BEARGRASS CREEK (056C00033N) (MP 0.018), A DISTANCE OF 0.01 MILES. BRIDGE REPAIRS SYP NO. 05-10020.00.

GEOGRAPHIC COORDINATES LATITUDE 38:14:03.00 LONGITUDE 85:41:13.00

COMPLETION DATE(S):

COMPLETED BY 04/15/2019

APPLIES TO ENTIRE CONTRACT

CONTRACT NOTES

PROPOSAL ADDENDA

All addenda to this proposal must be applied when calculating bid and certified in the bid packet submitted to the Kentucky Department of Highways. Failure to use the correct and most recent addenda may result in the bid being rejected.

BID SUBMITTAL

Bidder must use the Department's electronic bidding software. The Bidder must download the bid file located on the Bid Express website (www.bidx.com) to prepare a bid packet for submission to the Department. The bidder must submit electronically using Bid Express.

JOINT VENTURE BIDDING

Joint venture bidding is permissible. All companies in the joint venture must be prequalified in one of the work types in the Qualifications for Bidders for the project. The bidders must get a vendor ID for the joint venture from the Division of Construction Procurement and register the joint venture as a bidder on the project. Also, the joint venture must obtain a digital ID from Bid Express to submit a bid. A joint bid bond of 5% may be submitted for both companies or each company may submit a separate bond of 5%.

UNDERGROUND FACILITY DAMAGE PROTECTION

The contractor shall make every effort to protect underground facilities from damage as prescribed in the Underground Facility Damage Protection Act of 1994, Kentucky Revised Statute KRS 367.4901 to 367.4917. It is the contractor's responsibility to determine and take steps necessary to be in compliance with federal and state damage prevention directives. When prescribed in said directives, the contractor shall submit Excavation Locate Requests to the Kentucky Contact Center (KY811) via web ticket entry. The submission of this request does not relieve the contractor from the responsibility of contacting non-member facility owners, whom shall be contacted through their individual Protection Notification Center. Non-compliance with these directives can result in the enforcement of penalties.

REGISTRATION WITH THE SECRETARY OF STATE BY A FOREIGN ENTITY

Pursuant to KRS 176.085(1)(b), an agency, department, office, or political subdivision of the Commonwealth of Kentucky shall not award a state contract to a person that is a foreign entity required by [KRS 14A.9-010](#) to obtain a certificate of authority to transact business in the Commonwealth ("certificate") from the Secretary of State under [KRS 14A.9-030](#) unless the person produces the certificate within fourteen (14) days of the bid or proposal opening. If the foreign entity is not required to obtain a certificate as provided in [KRS 14A.9-010](#), the foreign entity should identify the applicable exception. Foreign entity is defined within [KRS 14A.1-070](#).

For all foreign entities required to obtain a certificate of authority to transact business in the Commonwealth, if a copy of the certificate is not received by the contracting agency within the time frame identified above, the foreign entity's solicitation response shall be deemed non-responsive or the awarded contract shall be cancelled.

Businesses can register with the Secretary of State at <https://secure.kentucky.gov/sos/ftbr/welcome.aspx>.

SPECIAL NOTE FOR PROJECT QUESTIONS DURING ADVERTISEMENT

Questions about projects during the advertisement should be submitted in writing to the Division of Construction Procurement. This may be done by fax (502) 564-7299 or email to kytc.projectquestions@ky.gov. The Department will attempt to answer all submitted questions. The Department reserves the right not to answer if the question is not pertinent or does not aid in clarifying the project intent.

The deadline for posting answers will be 3:00 pm Eastern Daylight Time, the day preceding the Letting. Questions may be submitted until this deadline with the understanding that the later a question is submitted, the less likely an answer will be able to be provided.

The questions and answers will be posted for each Letting under the heading "Questions & Answers" on the Construction Procurement website (www.transportation.ky.gov/contract). The answers provided shall be considered part of this Special Note and, in case of a discrepancy, will govern over all other bidding documents.

HARDWOOD REMOVAL RESTRICTIONS

The US Department of Agriculture has imposed a quarantine in Kentucky and several surrounding states, to prevent the spread of an invasive insect, the emerald ash borer. Hardwood cut in conjunction with the project may not be removed from the state. Chipping or burning on site is the preferred method of disposal.

INSTRUCTIONS FOR EXCESS MATERIAL SITES AND BORROW SITES

Identification of excess material sites and borrow sites shall be the responsibility of the Contractor. The Contractor shall be responsible for compliance with all applicable state and federal laws and may wish to consult with the US Fish and Wildlife Service to seek protection under Section 10 of the Endangered Species Act for these activities.

ACCESS TO RECORDS

The contractor, as defined in KRS 45A.030 (9) agrees that the contracting agency, the Finance and Administration Cabinet, the Auditor of Public Accounts, and the Legislative Research Commission, or their duly authorized representatives, shall have access to any books, documents, papers, records, or other evidence, which are directly pertinent to this contract for the purpose of financial audit or program review. Records and other prequalification information confidentially

disclosed as part of the bid process shall not be deemed as directly pertinent to the contract and shall be exempt from disclosure as provided in KRS 61.878(1)(c). The contractor also recognizes that any books, documents, papers, records, or other evidence, received during a financial audit or program review shall be subject to the Kentucky Open Records Act, KRS 61.870 to 61.884.

In the event of a dispute between the contractor and the contracting agency, Attorney General, or the Auditor of Public Accounts over documents that are eligible for production and review, the Finance and Administration Cabinet shall review the dispute and issue a determination, in accordance with Secretary's Order 11-004.

April 30, 2018

SPECIAL NOTE FOR RECIPROCAL PREFERENCE

RECIPROCAL PREFERENCE TO BE GIVEN BY PUBLIC AGENCIES TO RESIDENT BIDDERS

By reference, KRS 45A.490 to 45A.494 are incorporated herein and in compliance regarding the bidders residency. Bidders who want to claim resident bidder status should complete the Affidavit for Claiming Resident Bidder Status along with their bid in the electronic bidding software. Submittal of the Affidavit should be done along the bid in Bid Express.

April 30, 2018

EXPEDITE PROJECT WORK ORDER

The Contractor may request that the Department expedite the work order for this project to allow for maximization of time to complete the work. In order for the Department to accomplish this task, the Contractor may be required to “hand carry” all required project documentation to facilitate the process. Immediately UPON NOTIFICATION OF AWARD OF THE CONTRACT, deliver required project documentation to:

Division of Construction Procurement
200 Mero St.
Frankfort, KY 40602

Commonwealth of Kentucky
DEPARTMENT OF HIGHWAYS

**PLANS OF
PROPOSED PROJECT
BRIDGE REHABILITATION
CONTRACT NO. BK-013**

INDEX OF SHEETS

SHEET NO.	DESCRIPTION
1	TITLE & LOCATION MAP
2	MAINTENANCE OF TRAFFIC PLAN & ELEVATION
3	TYPICAL SECTION
4	TYPICAL SECTION
5	SITE DETWATERING (1 OF 2)
6	SITE DETWATERING (2 OF 2)
7	UPSTREAM SPANDREL & RAILING
8	DOWNSTREAM SPANDREL & RAILING
9	SPANDREL & RAILING DEFECT TABLE
10	ARCH (1 OF 2)
11	ARCH (2 OF 2)
12	ARCH WATERPROOFING (1 OF 3)
13	ARCH WATERPROOFING (2 OF 3)
14	ARCH WATERPROOFING (3 OF 3)
15	BRIDGE END DRAINAGE

DATE
8 / 17 / 18

SHEET NO.
1 OF 15



PREPARED BY:
AECOM

056C00033N
MILLVALE ROAD OVER
MIDDLE FORK BEARGRASS CREEK
38.234214, -85.687169

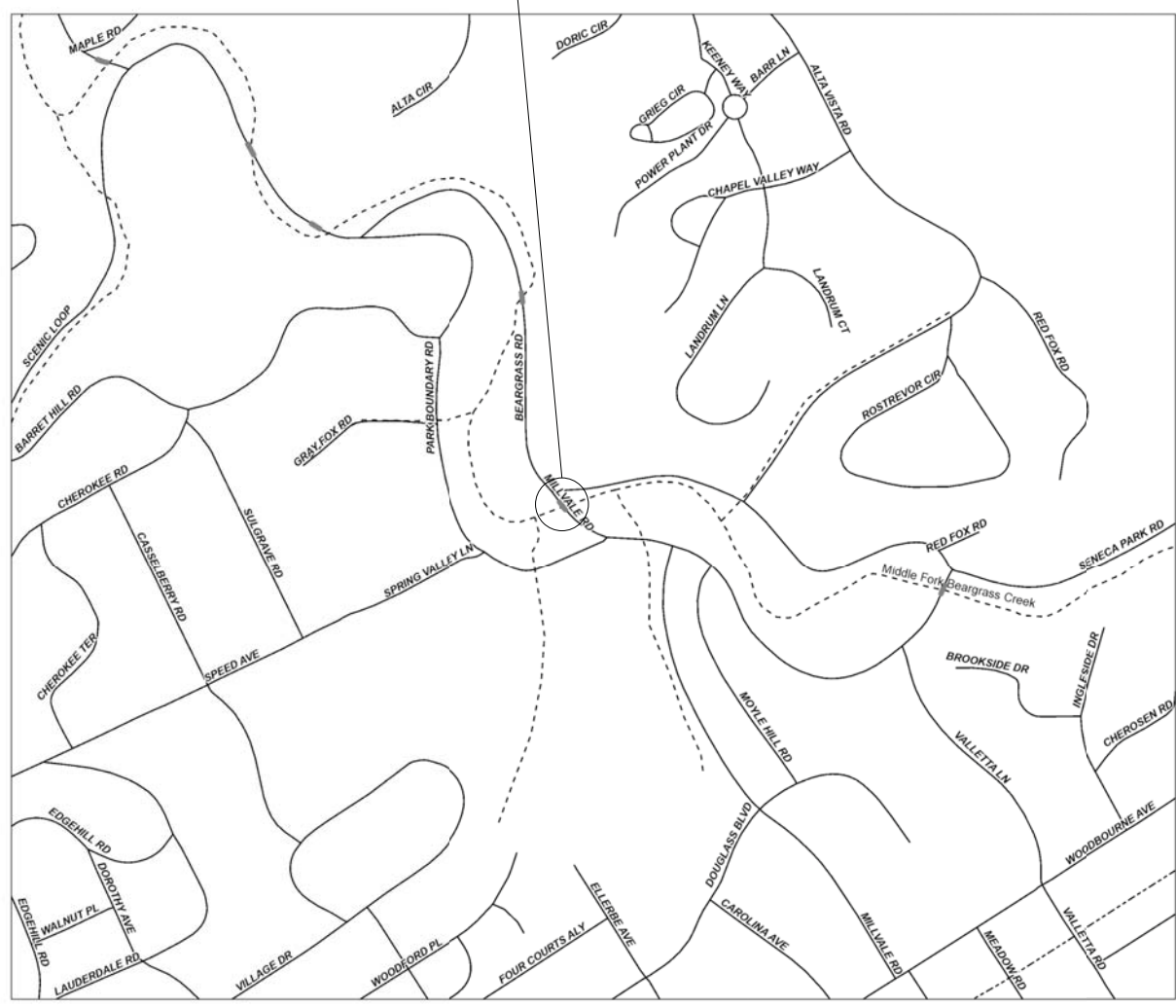

LOCATION MAP

SHEET TITLE:
TITLE & LOCATION MAP

COUNTY
JEFFERSON

CROSSING
MIDDLE FORK BEARGRASS CREEK

BRIDGE NUMBER
056C00033N

ROUTE
MILLVALE ROAD

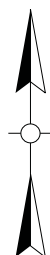
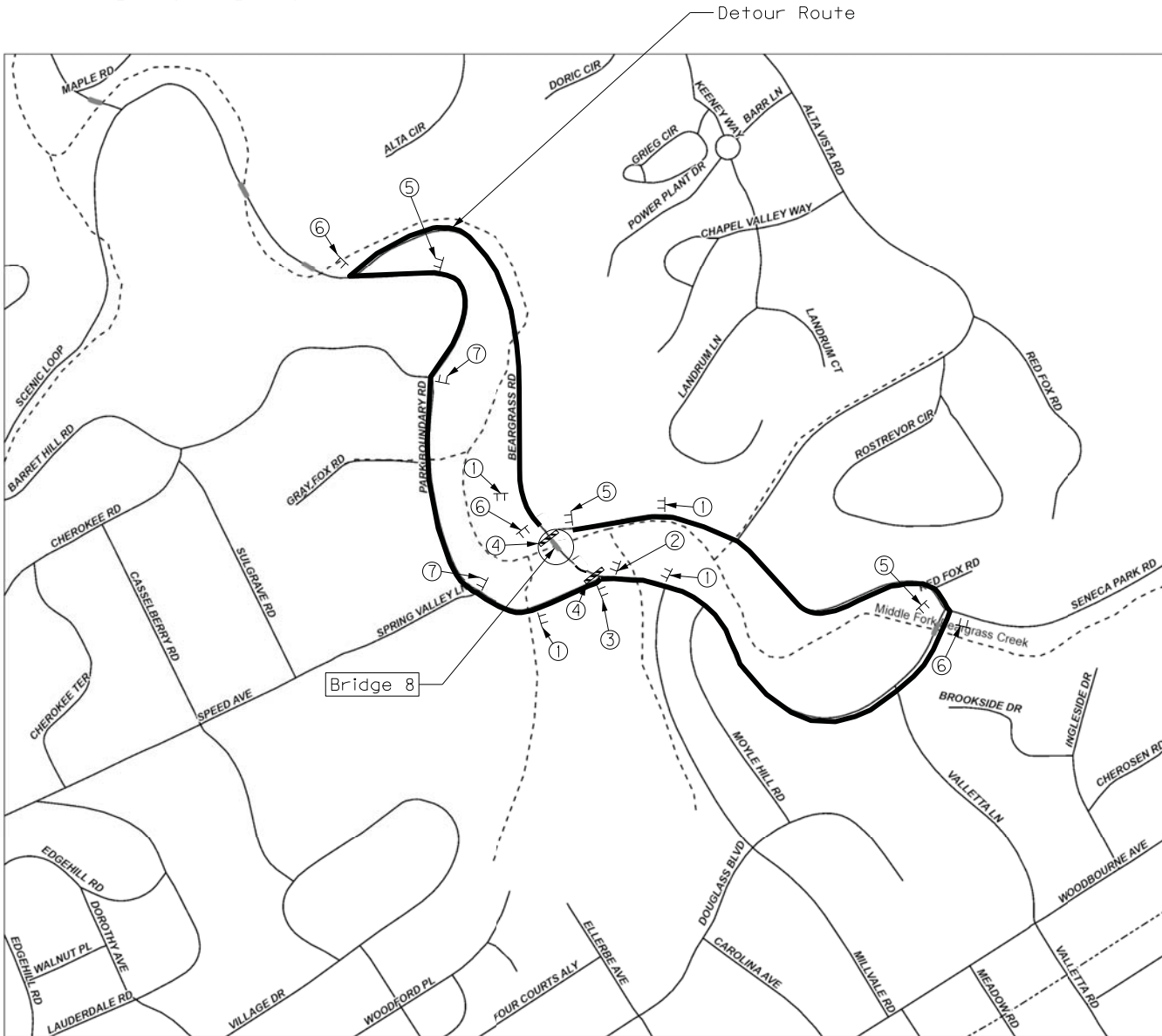
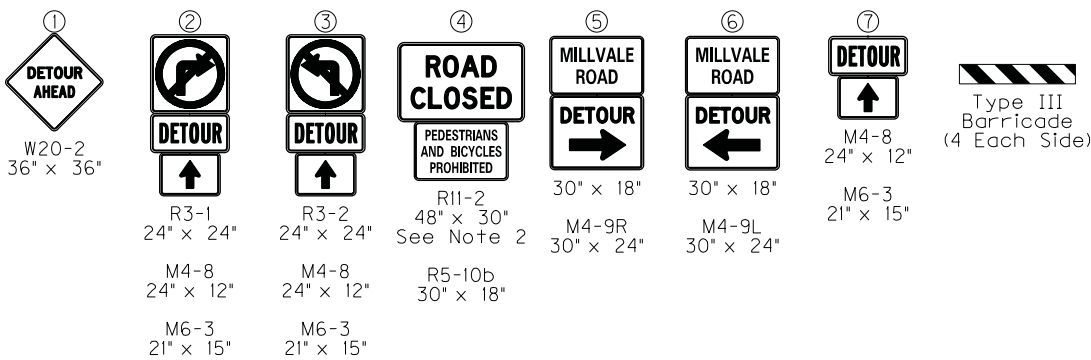

█ Vehicle Detour Route

- Notes:
- All traffic shall be detoured during structure closure in accordance with the Special Note for Traffic Control on Bridge Repair Contracts.
 - Road Closed sign to be mounted above one of the Type III Barricades.
 - All signs must conform to MUTCD & KYTC Standards.

DATE 8 / 17 / 18	SHEET NO. 2 OF 15
PREPARED BY: 	
MAINTENANCE OF TRAFFIC	
SHEET TITLE: JEFFERSON COUNTY CROSSING MIDDLE FORK BEARGRASS CREEK	
BRIDGE NUMBER 056C00033N	ROUTE MILLVALE ROAD

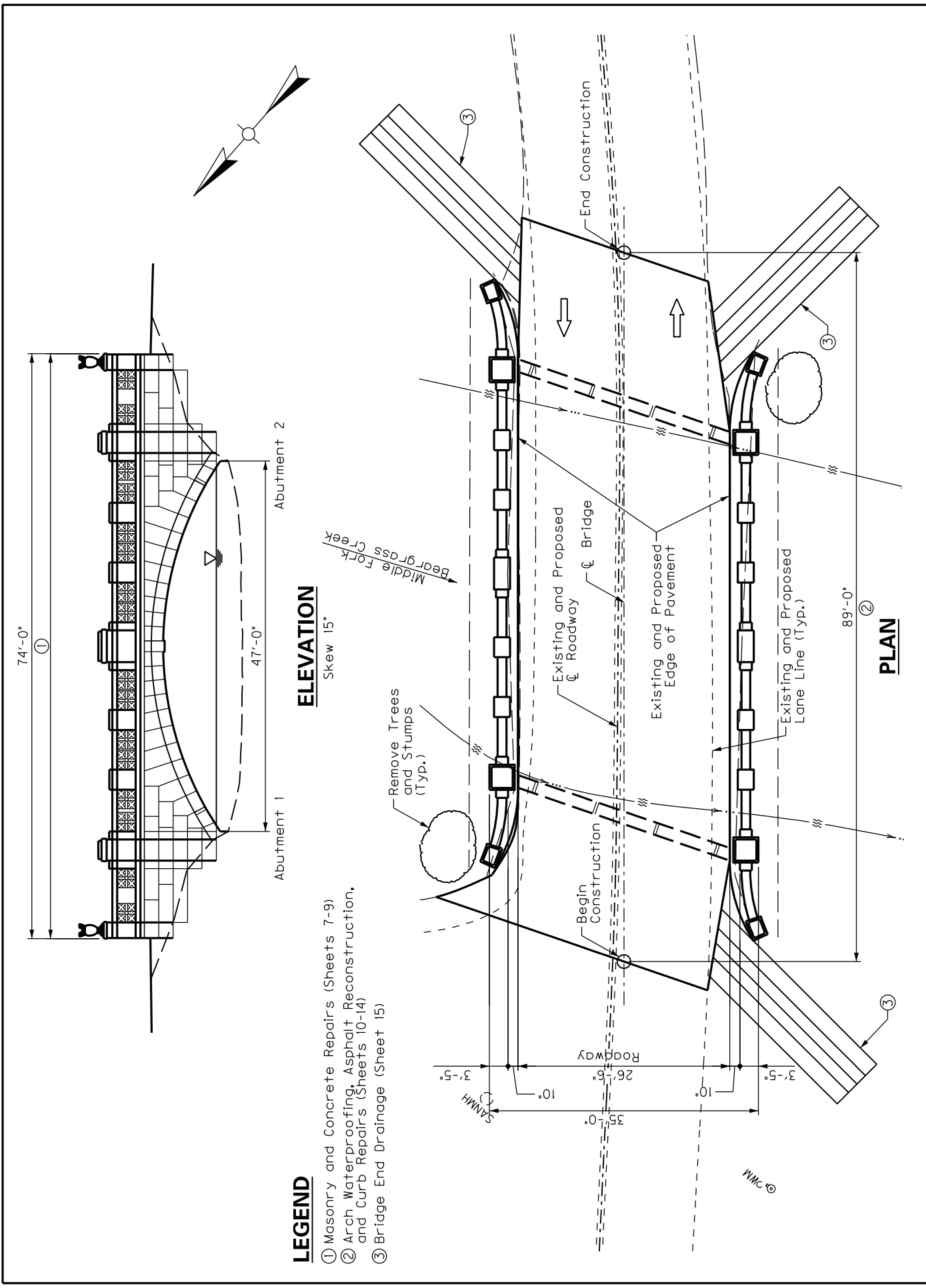

LEGEND

- ① Masonry and Concrete Repairs (Sheets 7-9)
- ② Arch Waterproofing, Asphalt Reconstruction, and Curb Repairs (Sheets 10-14)
- ③ Bridge End Drainage (Sheet 15)

BRIDGE NUMBER 056C00033N		COUNTY JEFFERSON		SHEET TITLE: MIDDLE FORK BEARGRASS CREEK	
ROUTE ROUTE		CROSSING		PLAN AND ELEVATION	
MILLVALE ROAD		AECOM		PREPARED BY:	
		BRIDGING KENTUCKY		DATE 8 / 17 / 18	
		SHEET NO. 3 OF 15			

DATE
8 / 17 / 18
SHEET NO.
4 OF 15



PREPARED BY:
AECOM

TYPICAL SECTION

SHEET TITLE:

COUNTY
JEFFERSON
CROSSING
MIDDLE FORK BEARGRASS CREEK

BRIDGE NUMBER
056C00033N
ROUTE
MILLVALE ROAD

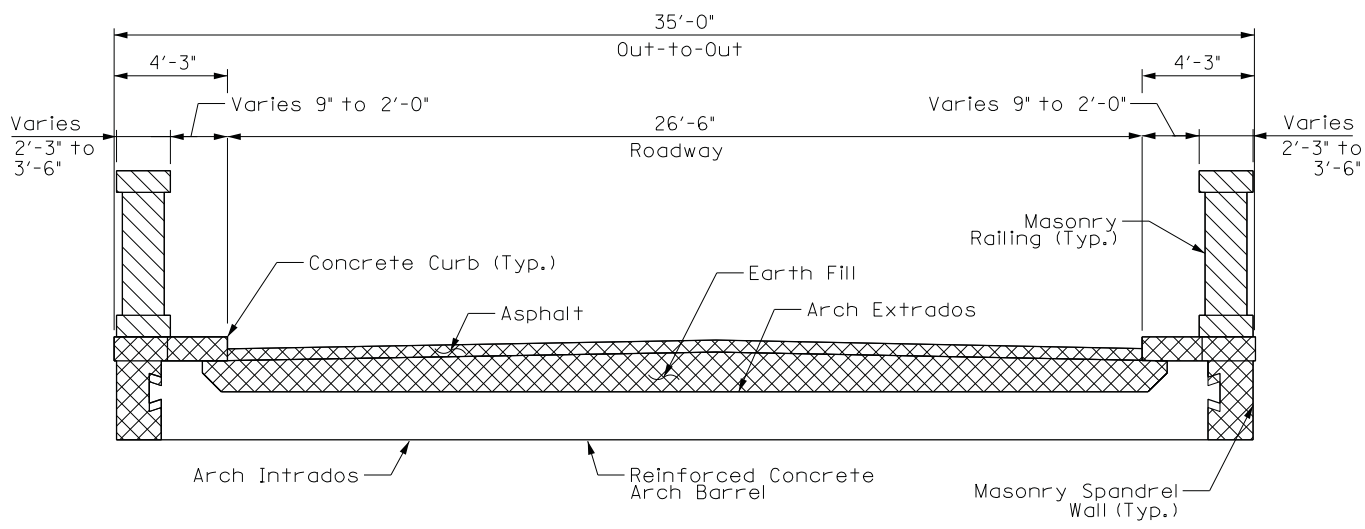

EXISTING TYPICAL SECTION

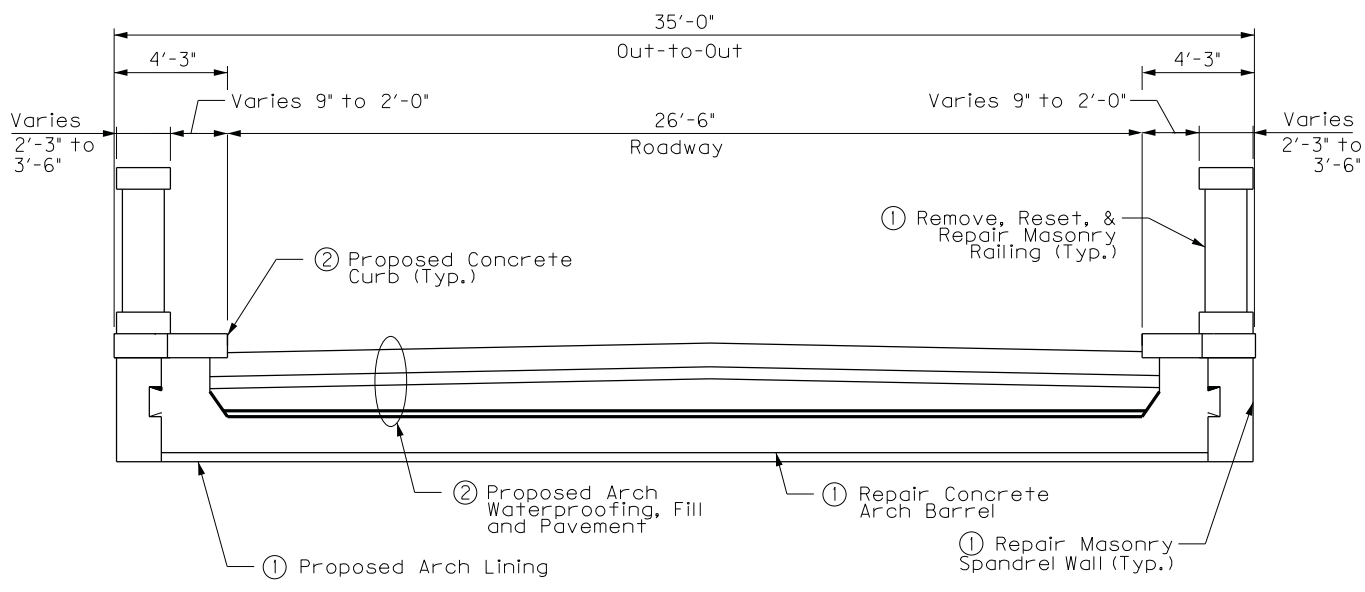

PROPOSED TYPICAL SECTION

LEGEND

- ① Masonry and Concrete Repairs (Sheets 7-9)
- ② Arch Waterproofing, Asphalt Reconstruction, and Curb Repairs (Sheets 10-14)

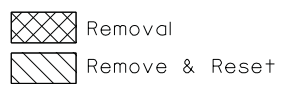

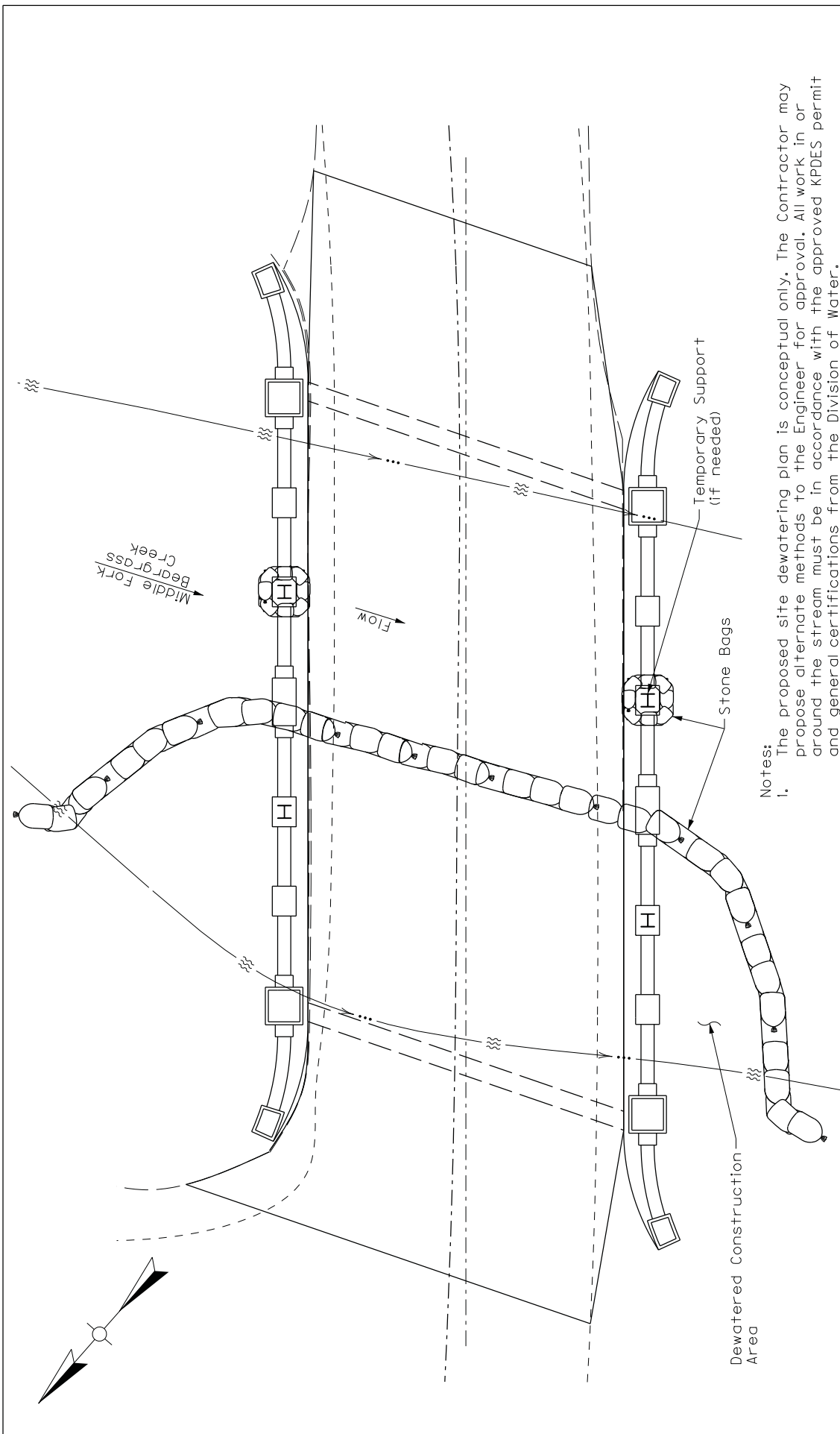

Notes:

1. The proposed site dewatering plan is conceptual only. The Contractor may propose alternate methods to the Engineer for approval. All work in or around the stream must be in accordance with the approved KPDES permit and general certifications from the Division of Water.
2. The Contractor is permitted to build, maintain and operate a flow barrier to divert stream flows away from construction work. The temporary stream diversion must discharge into the same natural drainage way. No more than 50% of the stream may be diverted at one time.
3. The flow barrier shall be made of non-erodible material, able to withstand the anticipated flows, and shall not contribute unnecessary pollution of the stream or surrounding area.
4. Payment for site dewatering is incidental to the item of work being performed.

PHASE I

BRIDGE NUMBER 056C00033N ROUTE	COUNTY JEFFERSON CROSSING	SHEET TITLE SITE DEWATERING	PREPARED BY: AECOM	DATE 8 / 17 / 18	SHEET NO. 5 OF 15
---	--	---------------------------------------	------------------------------	----------------------------	-----------------------------



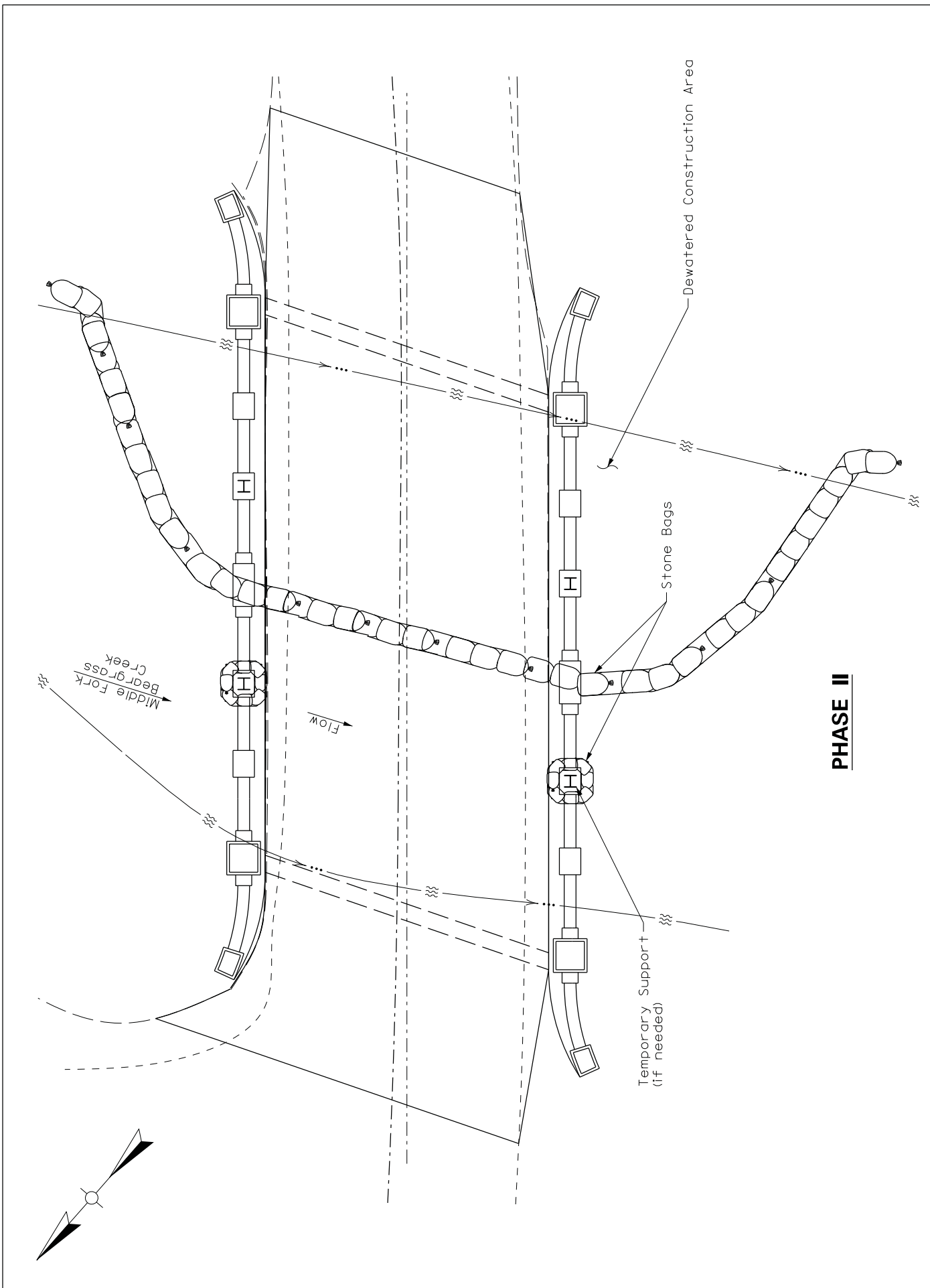

BRIDGE NUMBER 056C00033N	COUNTY JEFFERSON CROSSING MIDDLE FORK BEARGRASS CREEK	SHEET TITLE: SITE DEWATERING	PREPARED BY: AECOM
ROUTE MILLVALE ROAD	DATE 8 / 17 / 18	SHEET NO. 6 OF 15	BRIDGING KENTUCKY

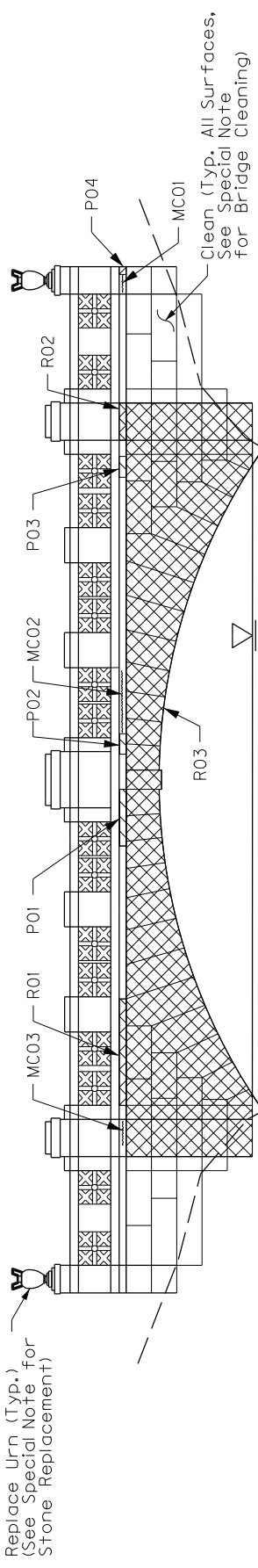

SPANDREL ELEVATION
(Looking Downstream)

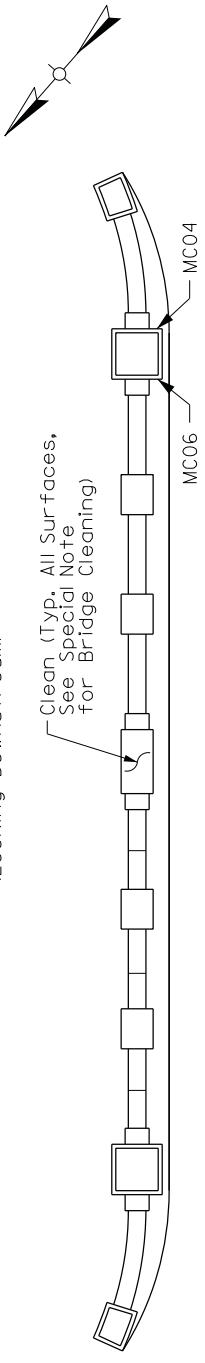

RAILING PLAN

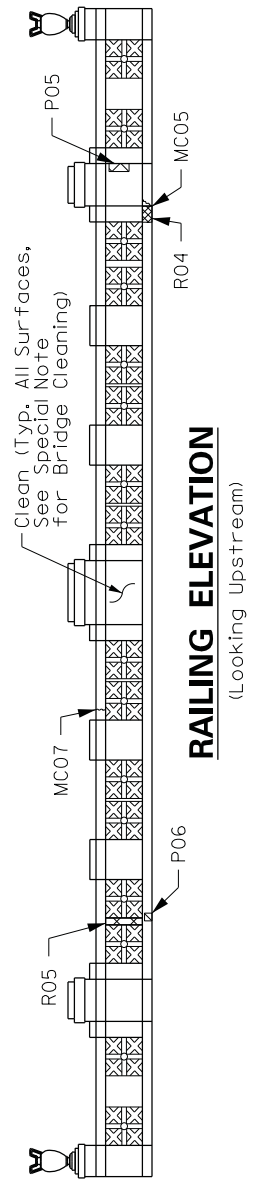

RAILING ELEVATION
(Looking Upstream)

LEGEND

- Masonry Patching (See Special Note for Masonry Patching Repairs)
- Masonry Cracking (See Special Note for Masonry Crack Repairs)
- Stone Replacement (See Special Note for Stone Replacement)
- Dutchman Repairs (See Special Note for Dutchman Repairs)
- PXX Patch ID (See Sheet 9 for Quantities)
- MCXX Masonry Crack ID (See Sheet 9 for Quantities)
- RXX Stone Replacement ID (See Sheet 9 for Quantities)

- Notes:
1. Repair limits shown are approximate and Contractor must field verify.
 2. Remove and preserve railing prior to performing spandrel repairs.

BRIDGE NUMBER 056C00033N	COUNTY JEFFERSON	SHEET TITLE: MIDDLE FORK BEARGRASS CREEK
ROUTE MILLVALE ROAD	CROSSING CROSSING	

PREPARED BY:
AECOM

UPSTREAM SPANDREL AND RAILING

DATE 8 / 17 / 18	SHEET NO. 7 OF 15
----------------------------	-----------------------------



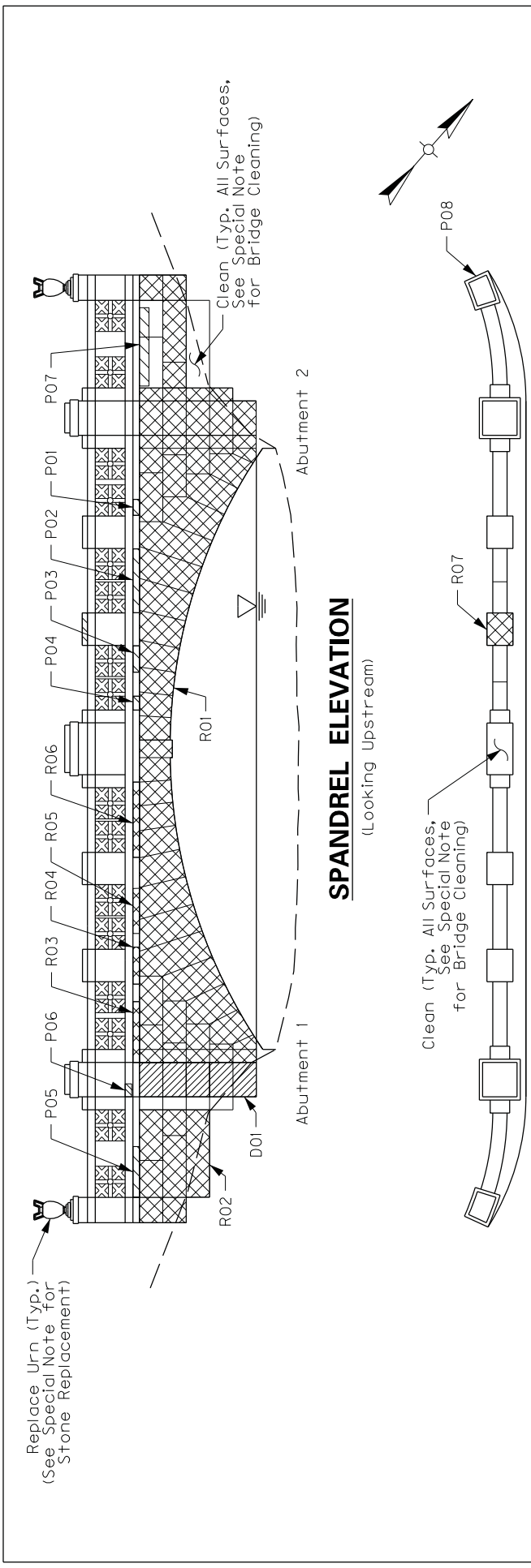

RAILING PLAN

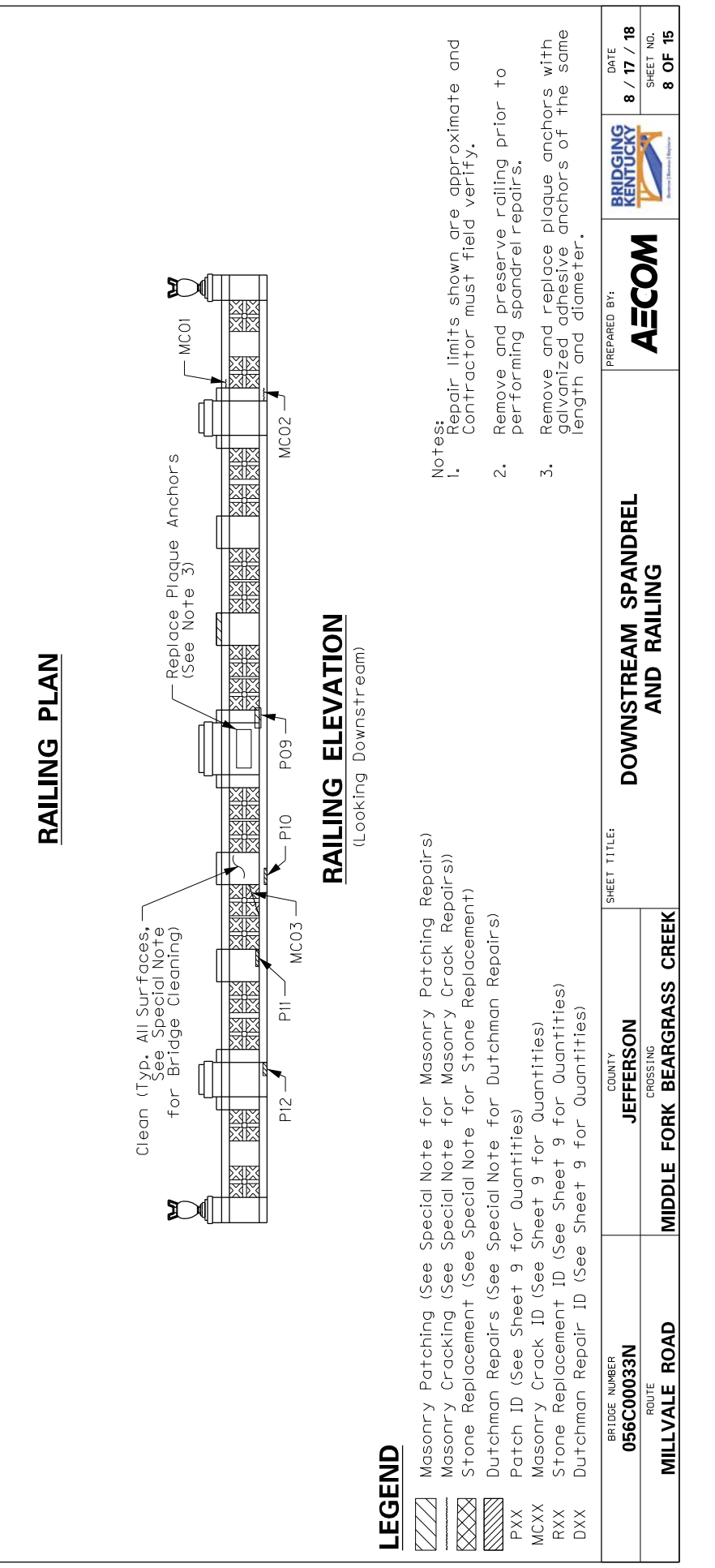

LEGEND

- Masonry Patching (See Special Note for Masonry Patching Repairs)
 - Masonry Cracking (See Special Note for Masonry Crack Repairs)
 - Stone Replacement (See Special Note for Stone Replacement)
 - Dutchman Repairs (See Special Note for Dutchman Repairs)
 - Patch ID (See Sheet 9 for Quantities)
 - Masonry Crack ID (See Sheet 9 for Quantities)
 - Stone Replacement ID (See Sheet 9 for Quantities)
 - Dutchman Repair ID (See Sheet 9 for Quantities)
- Notes:**
1. Repair limits shown are approximate and Contractor must field verify.
 2. Remove and preserve railing prior to performing spandrel repairs.
 3. Remove and replace plaque anchors with galvanized adhesive anchors of the same length and diameter.

BRIDGE NUMBER 056C00033N ROUTE MILLVALE ROAD	COUNTY JEFFERSON CROSSING MIDDLE FORK BEARGRASS CREEK	SHEET TITLE: DOWNSTREAM SPANDREL AND RAILING		PREPARED BY: AECOM	BRIDGING KENTUCKY 	DATE 8 / 17 / 18
					SHEET NO. 8 OF 15	

UPSTREAM			
DEFECT ID	TYPE	LOCATION	UNIT
MC01	Crack	Outboard	LF
MC02	Crack	Outboard	LF
MC03	Crack	Outboard	LF
MC04	Crack	Top of Railing	LF
MC05	Crack	Inboard	LF
MC06	Crack	Top of Railing	LF
MC07	Crack	Inboard	LF
R01	Stone Replacement	Outboard	SF
R02	Stone Replacement	Outboard	SF
R03	Stone Replacement	Outboard	SF
R04	Stone Replacement	Inboard	SF
R05	Stone Replacement	Inboard	SF
P01	Patch	Outboard	SF
P02	Patch	Outboard	SF
P03	Patch	Outboard	SF
P04	Patch	Outboard	SF
P05	Patch	Outboard	SF
P06	Patch	Inboard	SF
RP	Repoint		LF

* As needed in locations as directed by the Engineer.

DOWNSTREAM			
DEFECT ID	DESCRIPTION	LOCATION	UNIT
MC01	Crack	Inboard	LF
MC02	Crack	Inboard	LF
MC03	Crack	Inboard	LF
R01	Stone Replacement	Outboard	SF
R02	Stone Replacement	Outboard	SF
R03	Stone Replacement	Outboard	SF
R04	Stone Replacement	Outboard	SF
R05	Stone Replacement	Outboard	SF
R06	Stone Replacement	Outboard	SF
R07	Stone Replacement	Top of Railing	SF
D01	Dutchman Repair	Outboard	SF
P01	Patch	Outboard	SF
P02	Patch	Outboard	SF
P03	Patch	Outboard	SF
P04	Patch	Outboard	SF
P05	Patch	Outboard	SF
P06	Patch	Outboard	SF
P07	Patch	Outboard	SF
P08	Patch	End of Railing	SF
P09	Patch	Inboard	SF
P10	Patch	Inboard	SF
P11	Patch	Inboard	SF
P12	Patch	Inboard	SF
RP	Repoint		LF

* As needed in locations as directed by the Engineer.

Notes:
1. All quantities shown are approximated for estimating purposes and Contractor must field verify.
2. See Sheets 7 and 8 for defect locations.

BRIDGE NUMBER 056C00033N ROUTE MILLVALE ROAD	COUNTY JEFFERSON CROSSING MIDDLE FORK BEARGRASS CREEK	SHEET TITLE: SPANDREL & RAILING DEFECT TABLE	PREPARED BY: AECOM	BRIDGING KENTUCKY 	DATE 8 / 17 / 18
			SHEET NO. 9 OF 15		

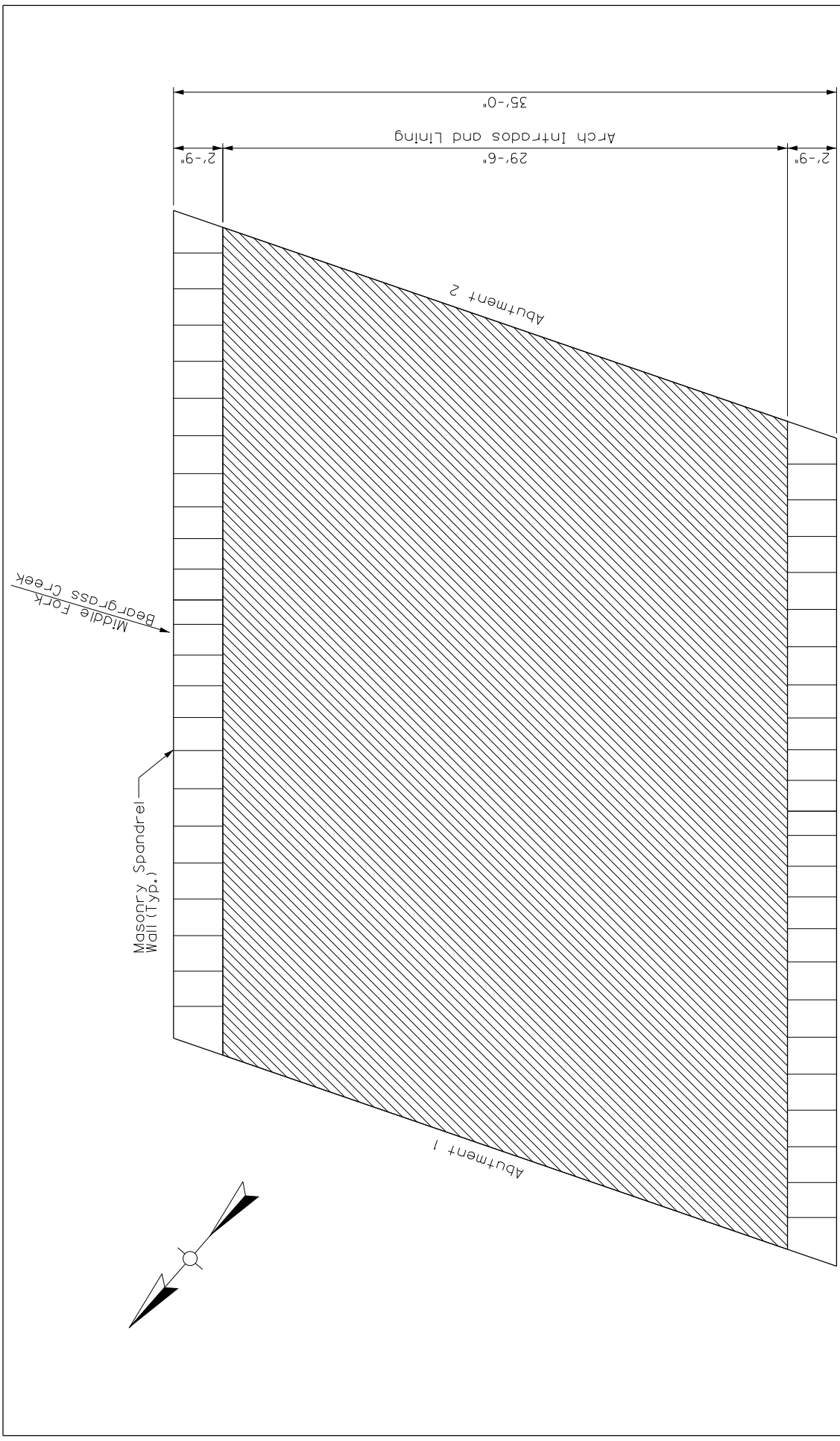

ARCH INTRADOS PLAN

LEGEND

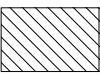
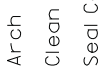
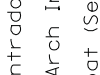
-  Arch Intradados Rehabilitation (See Special Note for Concrete Patching Repairs)
-  Clean Arch Intradados (Typ. All Surfaces, See Special Note for Bridge Cleaning)
-  Seal Coat (See Special Note for Concrete Sealing)

BRIDGE NUMBER 056C00033N ROUTE MILLVALE ROAD	COUNTY JEFFERSON CROSSING MIDDLE FORK BEARGRASS CREEK	SHEET TITLE: ARCH (1 OF 2)	PREPARED BY: AECOM		DATE 8 / 17 / 18 SHEET NO. 10 OF 15
	BRIDGING KENTUCKY				

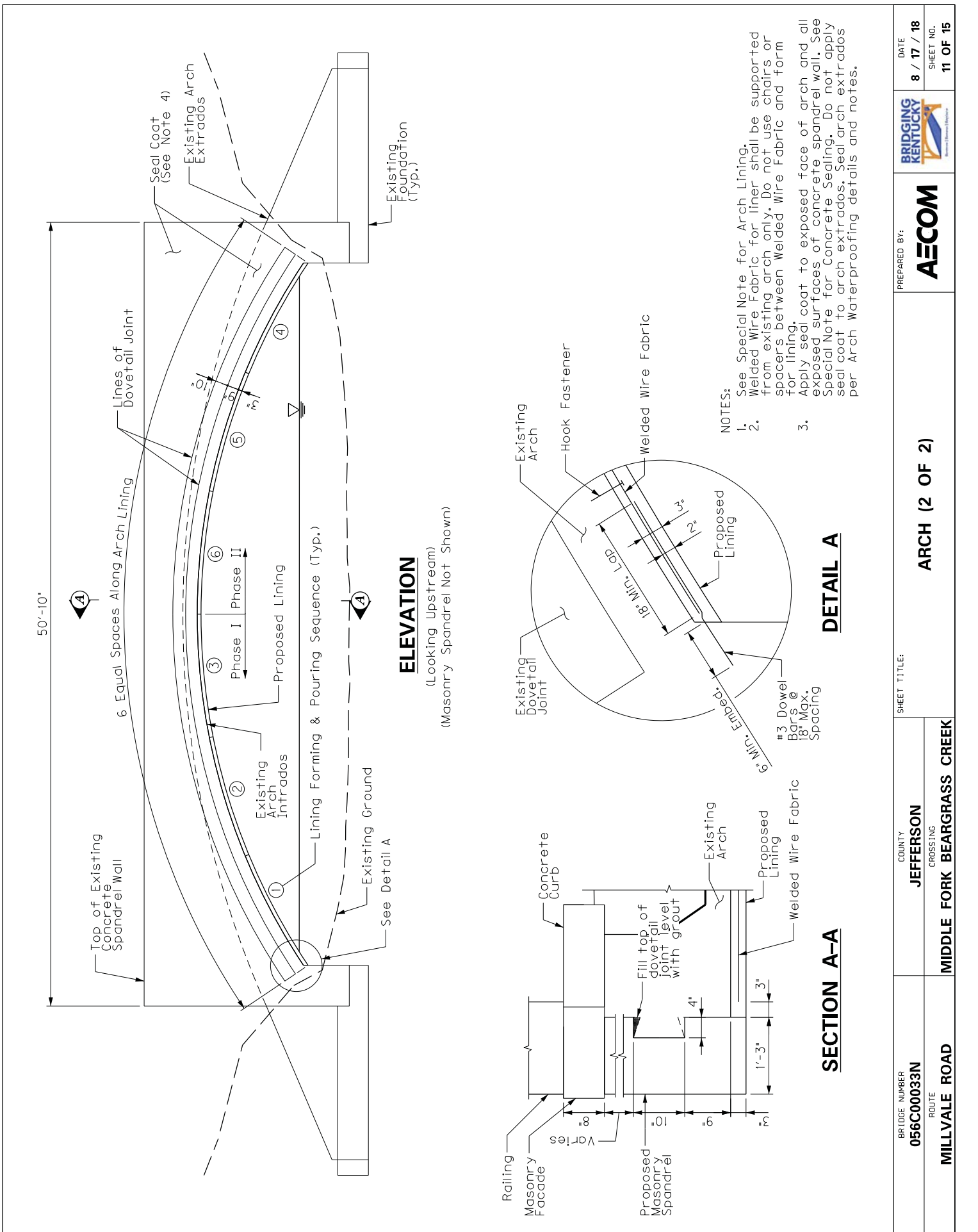

NOTES:

- See Special Note for Arch Lining.
- Welded Wire Fabric for liner shall be supported from existing arch only. Do not use chairs or spacers between Welded Wire Fabric and form for lining.
- Apply seal coat to exposed face of arch and all exposed surfaces of concrete spandrel wall. See Special Note for Concrete Sealing. Do not apply seal coat to arch extrados. Seal arch extrados per Arch Waterproofing details and notes.

ELEVATION

(Looking Upstream)
(Masonry Spandrel Not Shown)

DETAIL A

SECTION A-A

BRIDGE NUMBER 056C00033N ROUTE	COUNTY JEFFERSON CROSSING	SHEET TITLE: MIDDLE FORK BEARGRASS CREEK	PREPARED BY: AECOM	DATE 8 / 17 / 18
			BRIDGING KENTUCKY	SHEET NO. 11 OF 15

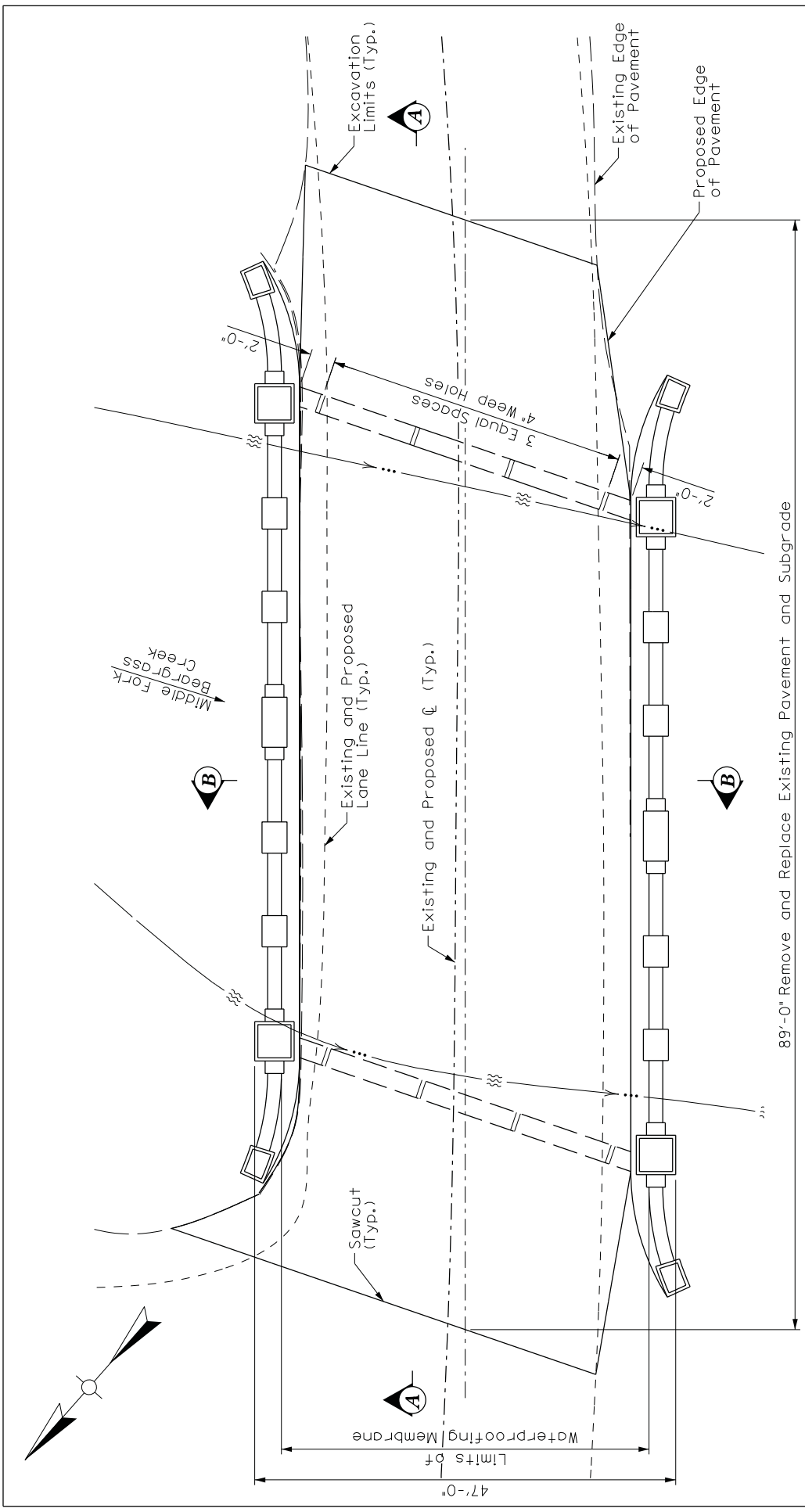

PLAN

- Notes:
1. Perform all work in accordance with the Special Note for Concrete Arch Waterproofing.
 2. See Sheet 13 for Sections A-A and B-B.
 3. Stripe pavement in accordance with Section 713 of the KYTC Standard Specification.

BRIDGE NUMBER 056C00033N ROUTE MILLVALE ROAD	COUNTY JEFFERSON CROSSING MIDDLE FORK BEARGRASS CREEK	SHEET TITLE: ARCH WATERPROOFING (1 OF 3)	PREPARED BY: AECOM DATE 8 / 17 / 18 SHEET NO. 12 OF 15
---	--	--	--

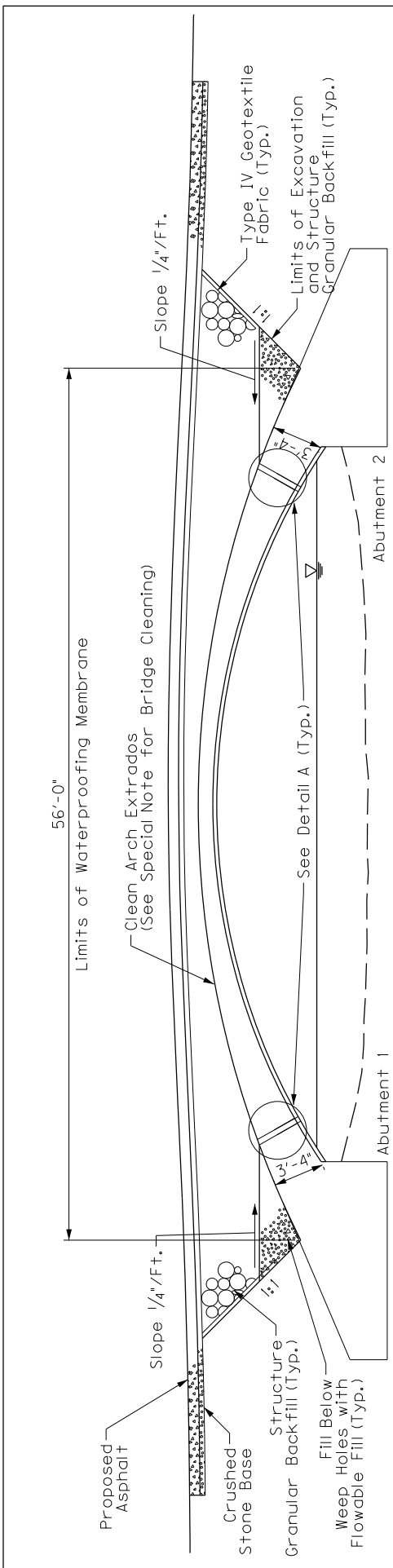

SECTION A-A

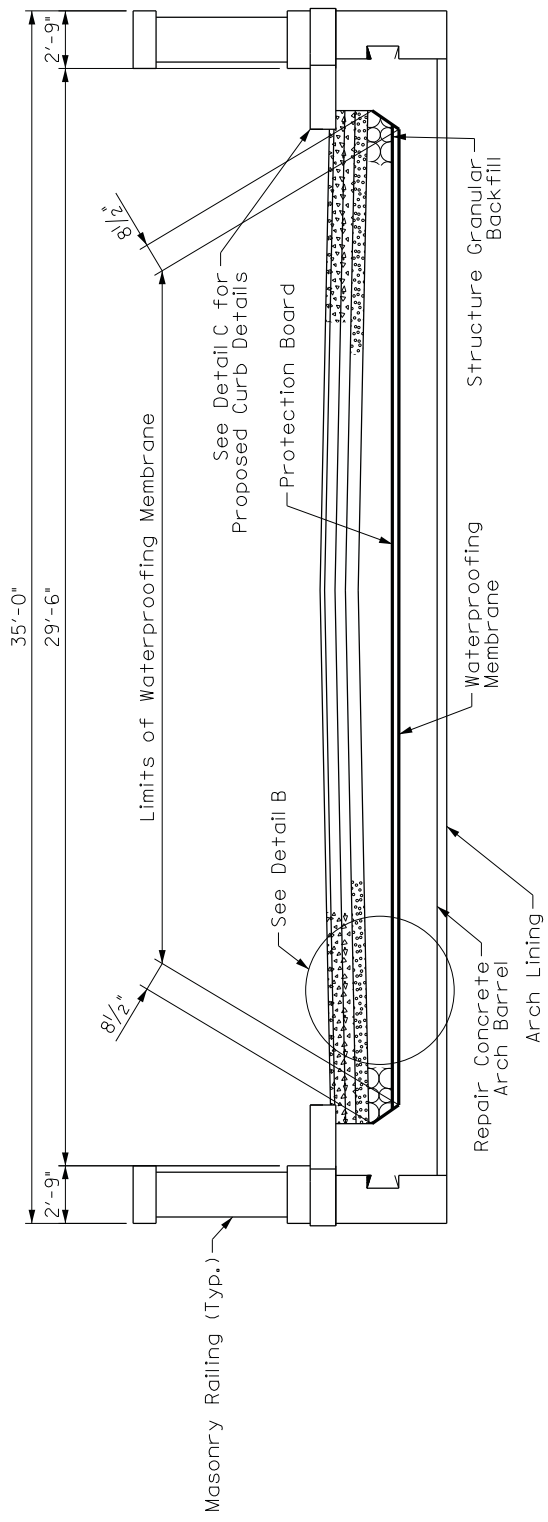

SECTION B-B

- Notes:
1. Perform all work in accordance with the Special Note for Concrete Arch Waterproofing.
 2. See Sheet 14 for Details A, B, and C.

BRIDGE NUMBER 056C00033N ROUTE MILLVALE ROAD	COUNTY JEFFERSON CROSSING MIDDLE FORK BEARGRASS CREEK	SHEET TITLE: ARCH WATERPROOFING (2 OF 3)	PREPARED BY: AECOM DATE 8 / 17 / 18 SHEET NO. 13 OF 15
---	--	--	--

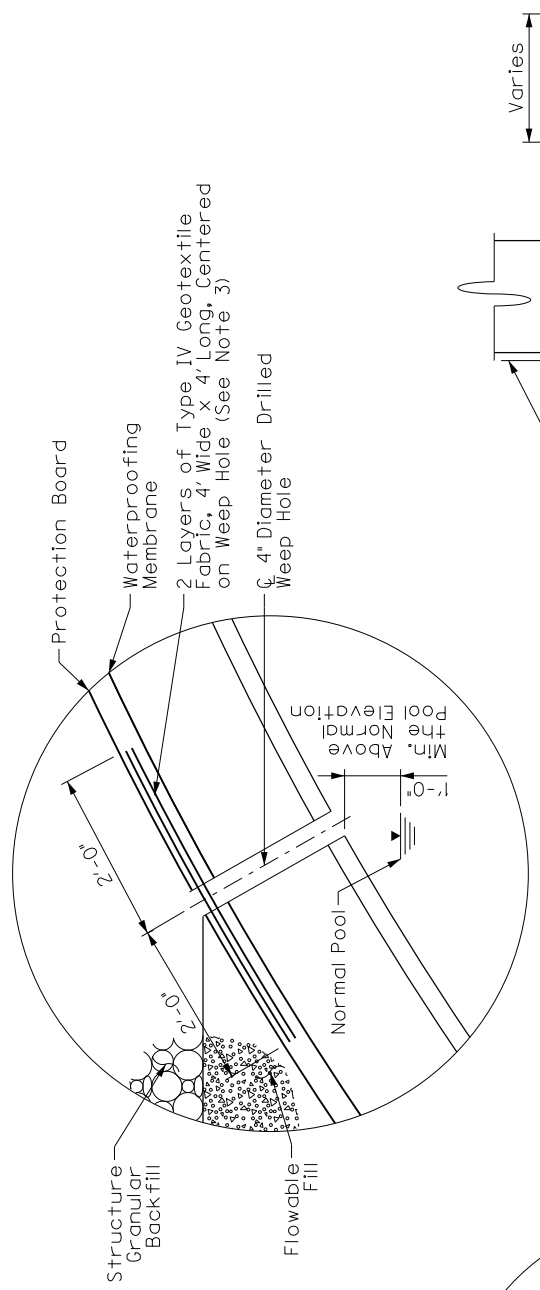

DETAIL A

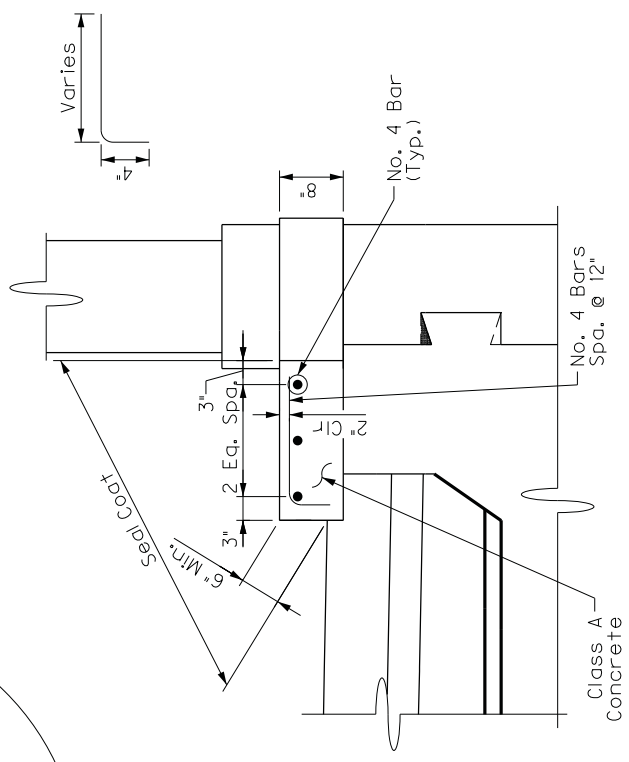

DETAIL C

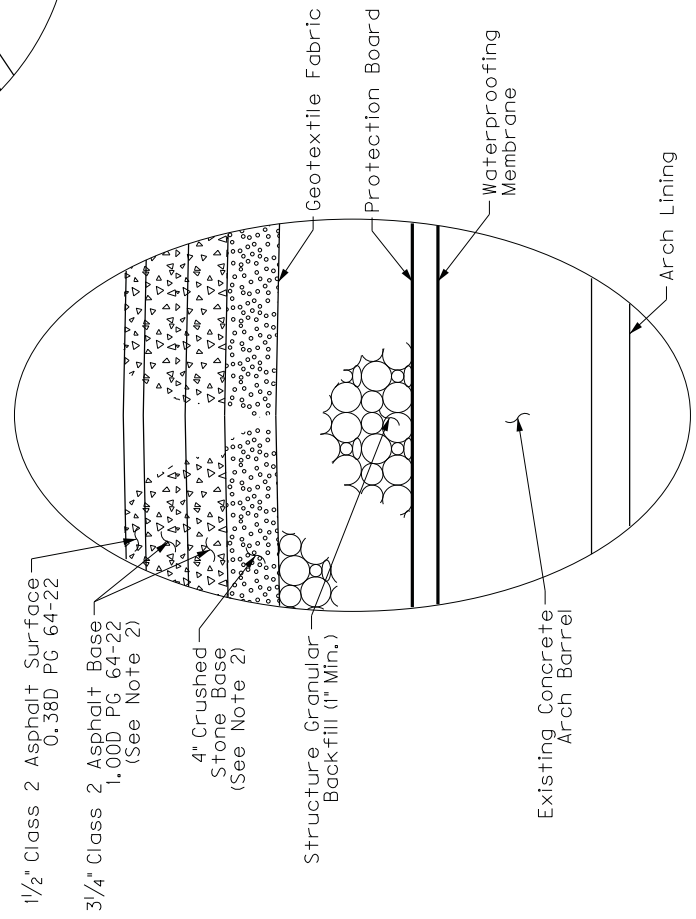

DETAIL B

- Notes:
1. Perform all work in accordance with the Special Note for Concrete Arch Waterproofing.
 2. The Engineer may allow a reduction in these dimensions at the crest of the arch in order to maintain the existing profile, if necessary.
 3. Secure geotextile fabric with 1/4" x #10 gage galvanized button head spikes through a 1" outside dia. #10 galvanized washer, spaced at 9" max. around the fabric perimeter.

BRIDGE NUMBER 056C00033N ROUTE MILLVALE ROAD	COUNTY JEFFERSON CROSSING MIDDLE FORK BEARGRASS CREEK	SHEET TITLE: ARCH WATERPROOFING (3 OF 3)		PREPARED BY: AECOM	DATE 8 / 17 / 18
				BRIDGING KENTUCKY 	SHEET NO. 14 OF 15

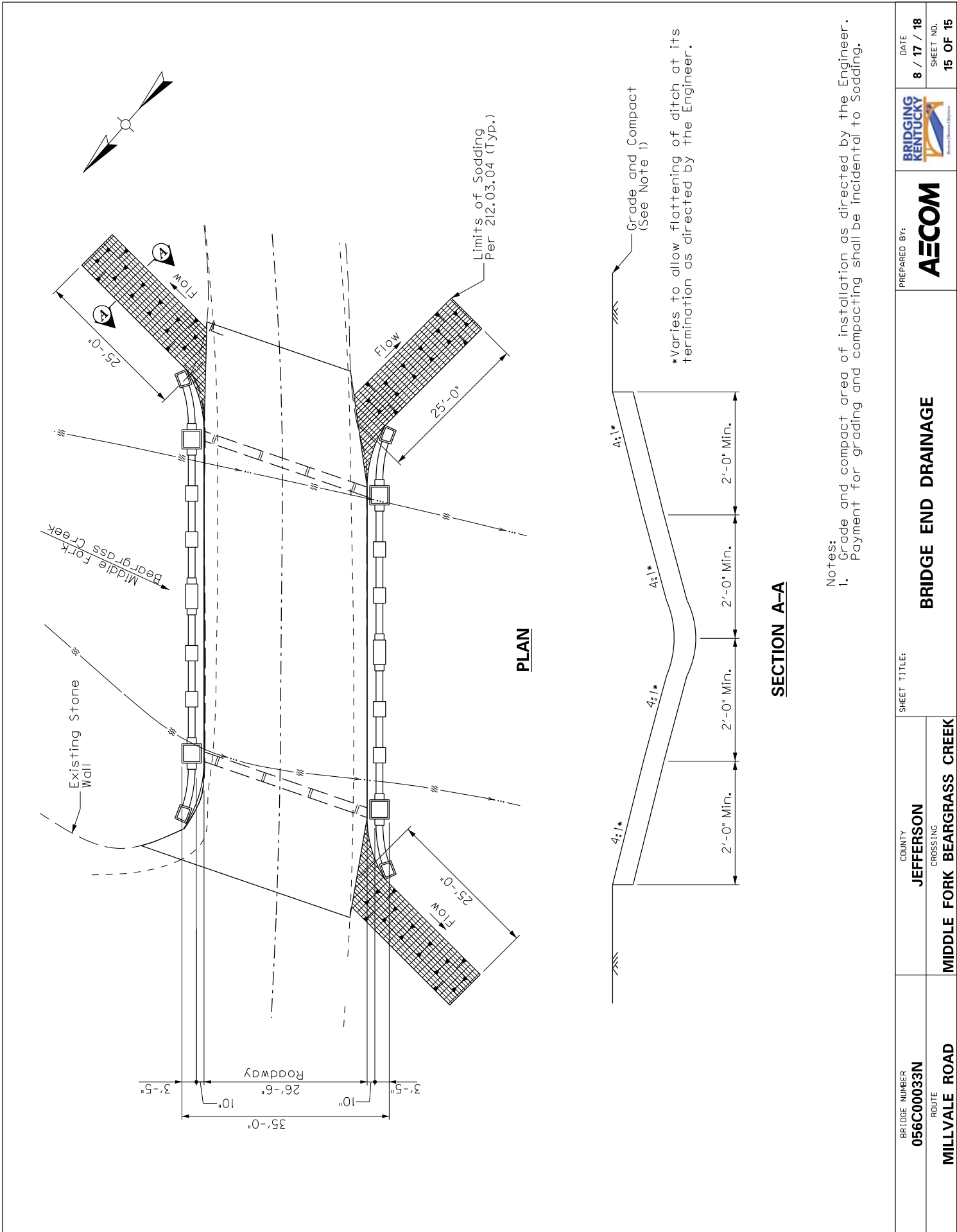

BRIDGING KENTUCKY

PREPARED BY:
AECOM

BRIDGE END DRAINAGE

SHEET TITLE:

COUNTY
JEFFERSON
CROSSING
MIDDLE FORK BEARGRASS CREEK

BRIDGE NUMBER
056C00033N
ROUTE
MILLVALE ROAD

DATE
8 / 17 / 18
SHEET NO.
15 OF 15

TABLE OF CONTENTS OF SPECIAL NOTES

	<i>Special Note</i>
I	<i>General Notes</i>
II	<i>Traffic Control on Bridge Repair Contracts</i>
III	<i>Erosion Prevention and Sediment Control</i>
IV	<i>Bridge Cleaning</i>
V	<i>Masonry Repairs</i>
VI	<i>Masonry Patching Repairs</i>
VII	<i>Masonry Crack Repairs</i>
VIII	<i>Repointing</i>
IX	<i>Dutchman Repairs</i>
X	<i>Stone Replacement</i>
XI	<i>Concrete Arch Waterproofing</i>
XII	<i>Arch Lining</i>
XIII	<i>Concrete Sealing</i>

I. GENERAL NOTES

SPECIFICATIONS

All references to the Standard Specifications are to the current edition of the Kentucky Department of Highways Standard Specifications for Road and Bridge Construction with current supplemental specifications. All references to the AASHTO Specifications are to the current edition of the AASHTO LRFD Bridge Design Specifications, with interims.

STANDARD DRAWINGS

Standard Drawings are not attached to these Plans. A Standard Drawing book may be obtained from the KYTC Policy Support Branch of the Department of Administrative Services in Frankfort, KY at (502) 564-3670. See other appropriate KYTC Standard Drawings where applicable.

MATERIALS DESIGN SPECIFICATIONS

Class "A" Reinforced Concrete	$F'c = 3,500$ psi
Class "M" Reinforced Concrete	$F'c = 4,000$ psi
Steel Reinforcement	$Fy = 60,000$ psi

EXISTING PLANS

Limited information is available and can be obtained from KYTC.

DETAILS AND DIMENSIONS

Details and dimensions of the existing bridges shown in the attached plans are approximate in nature and are shown for reference only. The contractor must base all quantity estimates, material procurement, and engineering based upon actual field measurements. New material that is unsuitable due to variations in the existing structure shall be replaced at the contractor's expense.

DAMAGE TO THE STRUCTURE

The contractor is responsible for any and all damage to the structure during construction.

REINFORCEMENT

Dimensions shown from the face of concrete to bars are to center of bars unless otherwise shown. Clear distance to face of concrete is 2" unless otherwise noted. Spacing of bars is from center to center of bars. All reinforcing bars shall be epoxy coated in accordance with Section 811.10 of the Standard Specifications.

KENTUCKY ONE CALL

Call KY 811 or 1-800-752-6007 #13450 toll free a minimum of two and no more than ten business days prior to excavation for information on the location of existing underground utilities which subscribe to the Kentucky One Call service. Coordinate excavation with all utility owners, including those who do not subscribe to Kentucky One Call.

INCIDENTAL ITEMS

The Contractor is required to complete the structure in accordance with the Plans and Specifications. Material or labor not otherwise specified is to be considered incidental to the Contractor.

CONSTRUCTION MATERIAL DISPOSAL

All concrete, asphalt material, and any other material that is required to be removed shall be disposed of off-site by the contractor at no additional cost to KYTC.

PROGRESS MEETINGS

The Contractor is required to hold periodic progress meetings to discuss material and mock-up approvals. The contractor shall invite KYTC, Louisville Metro Parks, and the Olmsted Parks Conservancy. Assume five meetings per bridge.

ADVISORY COMMITTEE

The Advisory Committee will make recommendations on the acceptance of qualifications, methods, materials, and mock-ups in order to assure that the historical significance of these structures is not altered during the rehabilitation. These areas are generally defined in the Special Notes; however, the Engineer may consult with the Advisory Committee on any topic. This Advisory Committee will consist of the following:

- Representative from Louisville Metro Parks
- Representative from Olmsted Parks Conservancy
- Louisville Metro Historic Preservation Officer.

COMPLETION OF THE STRUCTURE

The Contractor is required to complete the structures in accordance with the Plans and Specifications. Material, labor or construction operations, not otherwise specified, are to be included in the bid item most appropriate to the work involved. This may include shoring, excavations, backfilling, removal of all or parts of existing structures, incidental materials, labor or anything else required to complete the structure. After completion of all operations, the structure and site shall be left in a condition that is in accordance with Section 105.12 of the Specifications.

CONTRACT COMPLETION DATE

All construction activities are to be performed by April 15, 2019. No tree cutting is allowed between April 1st and October 14th due to environmental restrictions in order to mitigate affects to the bat habitat.

II. SPECIAL NOTE FOR TRAFFIC CONTROL ON BRIDGE REPAIR CONTRACTS

1.0 TRAFFIC CONTROL GENERAL. Except as provided herein, traffic shall be maintained in accordance with Section 112 of the current Standard Specifications and the current edition of the Manual of Uniform Traffic Control Devices (MUTCD). Except for the roadway and traffic control bid items listed, all items of work necessary to maintain and control traffic will be paid at the lump sum bid price to “Maintain and Control Traffic”.

Contrary to Section 106.01, traffic control devices used on this project may be new or used in new condition, at the beginning of work and maintained in like new condition until completion of the work.

2.0 TRAFFIC COORDINATOR. Furnish a Project Traffic Coordinator (PTC) as per Section 112. The PTC shall inspect the project maintenance of traffic, at least three times daily, or as directed by the Engineer, during the Contractor’s operations and at any time a lane closure is in place. The personnel shall have access on the project to a radio or telephone to be used in case of emergencies or accidents.

The PTC shall report all incidents throughout the work zone to the Engineer on the project. The Contractor shall furnish the name and telephone number where the PTC can be contacted at all times.

3.0 SIGNS. Contrary to Section 112.04.02, only long term signs (sign intended to be continuously in place for more than 3 days) will be measured for payment; short term signs (signs intended to be left in place for 3 days or less) will not be measured for payment but will be incidental to Maintain and Control Traffic.

4.0 PROTECTION OF WATERWAY UNDERNEATH. No material should be allowed to drop into the waterway below. The contractor shall adhere to all applicable permits.

5.0 PROTECTION OF PEDESTRIANS. Protect any excavation, obstructions, or construction work so as not to expose pedestrians to hazards. Chain link fencing should be in place to obstruct pedestrian access to the structures during all non-work hours while the structures are closed to traffic.

6.0 CONSTRUCTION PROCEDURES. A full closure of the structure must be approved by the Engineer at least two weeks prior. Full bridge closures are limited to 8 weeks.

All closures must be coordinated with Louisville Metro Parks (contact person is Erica Nelson: 502.456.3253).

Closures will not be permitted on these days:

Easter Weekend (Thursday-Sunday)

Memorial Day Weekend (Friday-Monday)

Independence Day, when July 4th is on Tuesday, Wednesday, or Thursday; or

Independence Day Weekend, when July 4th is on Monday (Saturday-Monday) or Friday (Friday-Sunday)
Labor Day Weekend (Friday-Monday)
Thanksgiving Day Weekend (Thursday-Sunday)
Christmas/New Years (December 24-January 2)

Outside of the closure period, single lane closures will be allowed by the Engineer in accordance with Standard Drawing TTC-100-03.

7.0 VARIABLE MESSAGE SIGNS. Variable message signs will be installed, operated, and maintained by the Contractor. The Engineer shall determine the location and wording on the signs. The signs should be available up to three weeks prior to beginning work and be available throughout the project.

8.0 DETOUR. The detour route is as specified in the detail drawings. This detour route signage must be in place at any time the roadway is closed. The signage must not be visible more than 24 hours prior to beginning of the closure or more than 24 hours following the ending of the closure. Detour signage must be installed through post mounting and will be measured for payment the first time it is installed.

9.0 PAYMENT. The Department will consider payment as full compensation for all work necessary for maintenance of traffic.

<u>Code</u>	<u>Pay Item</u>	<u>Pay Unit</u>
02014	Barricade-Type III	Each
02562	Temporary Signs	Square Foot
02650	Maintain & Control Traffic	Lump Sum
02671	Portable Changeable Message Sign	Each

III. SPECIAL NOTE FOR EROSION PREVENTION AND SEDIMENT CONTROL

The Contractor shall be responsible for filing the Kentucky Pollution Discharge Elimination System (KPDES) KYR10 permit Notice of Intent (NOI) with the Kentucky Division of Water (DOW) and any KPDES local Municipal Separate Storm Sewer System (MS4) program that has jurisdiction. The NOI shall name the contractor as the Facility Operator and include the KYTC Contract ID Number (CID) for reference.

The Contractor shall perform all temporary erosion/sediment control functions including: providing a Best Management Practice (BMP) Plan, conducting required inspections, modifying the BMP plan documents as construction progresses and documenting the installation and maintenance of BMPs in conformance with the KPDES KYR10 permit effective on August 1, 2009 or a permit re-issued to replace that KYR10 permit. This work shall be conducted in conformance with the requirements of Section 213 of KYTC 2012 Department of Highways, Standard Specifications for Road and Bridge Construction.

Contrary to Section 213.03.03, paragraph 2, the Engineer shall conduct inspections as needed to verify compliance with Section 213 of KYTC 2012 Department of Highways, Standard Specifications for Road and Bridge Construction. The Engineer's inspections shall be performed a minimum of once per month and within seven days after a storm of 1/2 inch rainfall or greater. Copies of the Engineer's inspections shall not be provided to the contractor unless improvements to the BMP's are required. The contractor shall initiate corrective action within 24 hours of any reported deficiency and complete the work within 5 days. The Engineer shall use Form TC 63-61 A for this report. Inspections performed by the Engineer do not relieve the Contractor of any responsibility for compliance with the KPDES permit.

Contrary to Section 213.05, bid items for temporary BMPs will not be listed and will be replaced with one lump sum item for the services. Payment will be pro-rated based on the Project Schedule as submitted by the Contractor and as agreed to by the Engineer.

The contractor shall be responsible for applying "good engineering practices" as required by the KPDES permit. The contractor may use any temporary BMPs with the approval of the KYTC Engineer.

The contractor shall provide the Engineer copies of all documents required by the KPDES permit at the time they are prepared.

The contractor shall be responsible for the examination of the soils to be encountered and make his own independent determination of the temporary BMPs that will be required to accomplish effective erosion prevention and sediment control.

The Contractor shall be responsible for filing the KPDES permit Notice of Termination (NOT) with the Kentucky DOW and any local MS4 program that has jurisdiction. The NOT shall be filed after the Engineer agrees that the project is stabilized or the project has been formally accepted.

The Department will make payment for the complete and accepted work under the following:

<u>Pay Item</u>	<u>Pay Unit</u>
KPDES Permit and Temp Erosion Control	LS

IV. SPECIAL NOTE FOR BRIDGE CLEANING

1.0 DESCRIPTION. Perform all work in accordance with the Kentucky Transportation Cabinet, Department of Highway's current Standard Specifications for Road and Bridge Construction and applicable Supplemental Specifications, the Standard Drawings, this Note, and the attached detail drawings. Section references are to the Standard Specifications.

This work consists of: (1) Furnish all labor, materials, tools, and equipment; (2) Provide safe access to the bridge substructure, spandrel walls, and railings in accordance with Section 107.01.01, for the Engineer to inspect and for workers to complete the cleaning; (3) Cleaning all surfaces exposed at any time during construction; (4) Maintain and control traffic; and (5) Any other work specified as part of this contract.

2.0 CONTRACTOR QUALIFICATIONS. The Contractor, Supervisor and workers performing Bridge Cleaning must be qualified to perform restoration of historic structures. The Contractor must submit, with their bid, their qualifications to perform the work. The Kentucky Transportation Cabinet has the right to reject bids at their discretion from nonqualified contractors. KYTC will consult with the Advisory Committee (as defined in the General Notes) before making a decision. The documentation of the Contractor's qualifications shall include, but is not limited to, the following:

- a. A description and location of three projects performed in the last four years involving the rehabilitation of mortar-masonry structures.
- b. Three references familiar with the quality of work performed by the Contractor.

3.0 CLEANING PRODUCTS.

3.1 Water. Obtain potable water from a local source. Filter to remove minerals resulting in a neutral pH, prior to application.

3.2 Paint Removers.

- a. Provide chemical paint removers which are water soluble, low toxicity products, effective for removal of paint on masonry or concrete without altering, damaging, or discoloring the masonry surface.
- b. Provide commercially available poulticing materials designed to adhere to and peel off paint without damaging the underlying masonry or project specific mixtures that include absorbent materials and cleaning solutions which can be demonstrated to do no harm to the masonry or concrete.

3.3 Chemical Cleaners. Do not use acidic chemical cleaners on limestone, marble, concrete and other calcareous (calcium containing) materials. If chemical cleaners are used on such materials, they shall be alkaline based and utilized with neutralizing afterwashes. Along with the cleaner, provide the associated pre and post treatment material to neutralize the long term effects of the chemicals. All products shall be commercially available and have a proven record of cleaning concrete and masonry without altering, damaging or discoloring the concrete, masonry, or mortar.

3.4 Biocides. Use biocides that are chemical treatments designed to remove organic growth from concrete and masonry. All products shall be commercially available and have a proven record of cleaning concrete and masonry without altering, damaging or discoloring the concrete, masonry, or mortar.

3.5 Cleaning Implements. Furnish brushes that contain natural or nylon fiber bristles only. Do not use wire brushes. Scrapers and application paddles shall be made of wood with rounded edges. Metallic tools are not permitted.

4.0 EQUIPMENT.

4.1 Cleaning Equipment. Cleaning equipment shall not cause staining, erosion, marring, or other damage or changes in the appearance of the surfaces to be cleaned.

4.2 Sandblasting. Sandblasting equipment is not allowed for cleaning concrete or masonry surfaces.

4.3 Water Blasting. Provide water blasting equipment including a trailer-mounted water tank, pumps, high-pressure hose, wand with safety release cutoff control, nozzle, and auxiliary water re-supply equipment. Do not operate the equipment at a pressure which will cause etching or other damage to the concrete or masonry surface or mortar joints. The water tank and auxiliary re-supply equipment shall be of sufficient capacity to permit continuous operations. Provide protective covers and barriers as required to prevent over-spray onto adjacent surfaces.

4.4 Spray Equipment. Spray equipment for chemical cleaners shall be low-pressure tanks or chemical pumps suitable for chemical cleaner indicated, and shall be equipped with stainless steel, cone-shaped spray-tip. Spray equipment for water shall disperse water through a fan-shaped spray tip at an angle of not less than 15 degrees. Spray equipment for heated water shall be capable of maintaining temperature between 140 and 180 degrees F. Keep the spray-tip at a 10-inch minimum distance from the wall surface during operations.

5.0 CONSTRUCTION.

5.1 General. Clean the concrete and masonry surfaces, and any bridge plaques, free of metallic, dirt, debris, graffiti, grime and organic stains, algae, rust, efflorescence and other contaminants.

Submit the cleaning and restoration methods, and the cleaning products selected for a specific structure to the Engineer for approval before work starts. The Engineer will approve or disapprove the method pending recommendations from the Advisory Committee (as defined in the General Notes).

5.2 Cleaning. Bridge materials shall not be damaged or marred in the process of cleaning. Protect open joints to prevent water and cleaner intrusion into the interior of the structure from pressure spraying. Protect non-concrete or masonry materials and severely deteriorated concrete or masonry by approved methods prior to initiation of cleaning operations. Cleaning shall remove all organic and inorganic contaminants from the surface and pores of the substrate, without causing any short or long-term negative consequences. Surfaces shall be evenly cleaned with no evidence of streaking or bleaching. The cleaning process shall not affect the density, porosity, or color of the concrete, masonry, or mortar. Cleaned concrete and masonry shall have a neutral pH. Use the gentlest methods possible for cleaning historic materials to achieve the desired results. Make test patches to determine a satisfactory cleaning result. Cleaning shall proceed in an orderly manner, working from top to bottom from one end of each elevation to the other. Perform cleaning in a manner which results in uniform coverage of all surfaces, including corners, moldings, interstices and which produces an even effect without streaking or damage to concrete or masonry. The cleaning materials, equipment, and methods shall not result in staining, erosion, marring, or other damage to the surfaces of the structure. Following an initial inspection and evaluation of the structure and surfaces, give the structure a surface cleaning which shall be completed prior to start of repair work. The work shall provide for the complete cleaning of all surfaces of the structures that are exposed at any point during construction, removing all traces of moss, dirt, and other contaminants to allow determination of the material's color and shades, finish and texture, and other properties. Following completion of the surface cleaning of the structure (or side of structure) the concrete and masonry shall be dried prior to the start of any repair work. The following sequence of methods shall be used to determine the least aggressive, effective cleaning method:

- a. Water with brushes.
- b. Water with mild soap.
- c. Water with stronger soap.
- d. Water with stronger soap plus ammonia.
- e. Water with stronger soap plus vinegar (but not on calcareous masonry).
- f. Stronger chemical cleaners, only when above methods are determined to be ineffective by the contractor.

5.3 Test Patches. Demonstrate the materials, equipment, and methods to be used in cleaning in a test section approximately 3 feet by 3 feet. The location of the test section, and the completed test section is subject to approval. Adjust the cleaning process as required and the test section rerun until an acceptable process is obtained. Locate test patches in inconspicuous areas of the bridge. The areas tested shall exhibit soiling characteristics representative of those larger areas to be cleaned. Allow tested areas to dry before a determination is made on the effectiveness of a particular treatment.

5.4 Water Cleaning.

5.4.1 Pressure Spraying. Spray water to surfaces to comply with requirements indicated by test patches for location, purpose, water temperature, pressure,

volume, and equipment. Unless otherwise indicated, the surface washing shall be done with clean, low pressure water (pressure of less than 55 psi and 2.5 to 3 gpm discharge) and the spray nozzle shall not be held less than 12 inches from surface of concrete or masonry. Water shall be applied side to side in overlapping bands to produce uniform coverage.

5.4.2 Hand Scrubbing. Scrub surfaces to be cleaned to remove surface contaminants. Pre-wet surfaces and use hand-held natural bristle or nylon brushes. Do not use wire brushes.

5.4.3 Rinsing. Rinse scrubbed surfaces clean of all contaminants and cleaning solutions with water in a low-to-moderate pressure spray, working upwards from bottom to top of each treated area. The rinsing cycle shall remove all traces of contaminants and cleaning solutions.

5.5 Chemical Cleaning. Chemical cleaning of historic concrete and masonry shall use the gentlest means possible to achieve the desired result as determined by test patches. Chemical cleaning is the use of any product in addition to water, including detergents, ammonia, vinegar, and bleach. Proceed in an orderly manner, working from top to bottom and from one end of each elevation to the other. Cleaning shall result in uniform coverage of all surfaces, including corners, moldings, interstices and produce an even effect without streaking or damage to material. Do not apply chemical cleaners to the same surfaces more than twice.

5.5.1 Surface Prewetting. Wet surfaces to be cleaned with chemical cleaners with water using a low pressure spray before application of any cleaner.

5.5.2 Alkaline Chemical Cleaning - Prewash Phase. Apply alkaline chemical cleaners to concrete and masonry surfaces according to manufacturer's instructions, by low pressure spray 50 psi max., roller, or brush. Cleaner shall remain on the material surface for the time period recommended by the manufacturer. Manual scrubbing by brushes shall be employed as indicated by test patches for the specific location. Cleaned surfaces shall be rinsed with a low-to-moderate pressure spray of water.

5.5.3 Alkaline Chemical Cleaning - Afterwash Phase. Immediately after rinsing of alkaline cleaned surfaces, apply a neutralizing afterwash to the cleaned areas. Neutralizing afterwash shall be applied according to manufacturer's instructions, by low pressure spray 50 psi max., roller, or brush. Afterwash shall remain on the surface for the time period recommended by manufacturer. Cleaned surfaces shall be rinsed with a low-to-moderate pressure spray of water to remove all traces of chemical cleaners.

5.5.4 pH Testing. Determine the pH of concrete and masonry surfaces which have been chemically cleaned using pH monitoring pencils or papers. Rinse

chemically cleaned materials of all chemical residues until a neutral pH (7) reading is obtained from the surface.

6.0 MEASUREMENT. The Department will measure the quantity of Clean by lump sum. The Department will not measure preparation of the site for the Engineer's access and will consider them incidental to Clean.

7.0 PAYMENT. Payment at the contract unit price per cubic foot is full compensation for all labor, equipment, and materials for the bridge cleaning.

The Department will consider payment as full compensation for all work required by this note and the attached detail drawings.

<u>Code</u>	<u>Pay Item</u>	<u>Pay Unit</u>
24492EC	Clean	Lump Sum

V. SPECIAL NOTE FOR MASONRY REPAIRS

1.0 DESCRIPTION. Perform all work in accordance with the Kentucky Transportation Cabinet, Department of Highway's current Standard Specifications for Road and Bridge Construction and applicable Supplemental Specifications, the Standard Drawings, this Note, and the attached detail drawings. Section references are to the Standard Specifications.

Coordinate this note with the Special Note for Dutchman Repairs, the Special Note for Masonry Crack Repairs, the Special Note for Masonry Patching Repairs, the Special Note for Repointing, the Special Note for Stone Replacement, and the Special Note for Bridge Cleaning.

2.1 QUALITY ASSURANCE SAMPLING, TESTING, AND ACCEPTANCE.

2.2 Contractor Qualifications. The Contractor, supervisor, and craftspeople must be qualified to perform historic masonry repairs. The Apparent Low Bidder must submit their qualifications to perform the work to Royce Meredith (Royce.Meredith@ky.gov) prior to Award of the Contract. The Kentucky Transportation Cabinet has the right to reject bids at their discretion from nonqualified contractors. KYTC may consult with an Advisory Committee before making a decision. The documentation of the Contractor's qualifications shall include, but is not limited to, the following:

- a. A description and location of three projects performed in the last four years involving the rehabilitation of mortar-masonry structures.
- b. Three references familiar with the quality of work performed by the Contractor.

2.3 Mortar Analysis. Analyze existing original historic mortar before repointing or performing any repairs that require repointing in order to provide a match with the new repointing mortar. Full laboratory analysis of the existing mortar shall conform to ASTM C1324, and include methods for precise determination of the binder constituents.

Take and analyze samples of unweathered original historic mortar and different type of mortar in the structure in order to match the new mortar to be used for repointing. Remove three or four samples of each type of mortar to be matched with a hand chisel from several locations on the bridge. Set aside the largest sample for comparison with the repointing mortar. Place the remaining samples in labeled, sealed sample bags for transport to the laboratory.

Field analysis of the existing mortar shall be as specified as below:

- a. Analyze the mortar composition and detect cracks, degradation and de-bonding from the surrounding masonry. Also determine previous surface coating treatments that may be contributing to the current conditions.
- b. Compare the bedding mortar with the pointing mortar and determine the cross-sectional characteristics of the wall.
- c. Determine the level of moisture movement in the insitu mortar, and if the mortar or masonry units are handling the brunt of the water movement through the wall.
- d. Assess the physical characteristics of the mortar and determine indirect compressive strength. Gather data on insitu mortar joint shear strength.

2.4 Restoration Mock-up. Submit the restoration methods, and materials selected for a specific structure for approval before work starts. No patching, grout or mortar

material shall be used in the work until the mock-ups and the represented material and workmanship have been approved. Materials shall be submitted and approved prior to the creation of mock-ups. The placement, size, and location of mock-ups will be in a less visible area of the bridge as directed by the Engineer. The Contractor must gain approval from the Engineer on their proposed methods, materials, and mock-up before beginning work. The Engineer will consult with the Advisory Committee (as defined in the General Notes) before making a decision.

Mock-ups must demonstrate the methods and quality of workmanship to be performed in each treatment.

- a. Prepare mock-ups on existing masonry under the same weather conditions expected during the remainder of the work.
- b. Throughout restoration, retain approved mock-up panels in undisturbed condition, suitably marked, as a standard for judging completed work.
- c. Review manufacturer's product data sheets to determine suitability of each product for each surface.
- d. Apply products using manufacturer-approved application methods, determining actual requirements for application.
- e. Obtain approval as to the preservation treatment approach, design, and workmanship to include, but not limited to the verification of all material applications and finishes as specified to the requirements of color, texture, profiles, and finishes before proceeding with work.
- f. Mock-ups: May be performed on inconspicuous sections of actual construction
 1. Location and number of mock-ups as directed by the Engineer.
 2. Size: two feet by two feet for patching or dutchman and six feet for repointing or crack repair, or as appropriate for the repair specified.
 3. Repair unacceptable work.

3.1 EQUIPMENT.

3.2 Compressed Air Supplies. Compressed air equipment shall deliver clean, oil and moisture free compressed air at the surface to be cleaned. Test the compressed air supply during each shift for the presence of oil and moisture.

4.1 FIELD CONDITIONS.

4.2 General Ambient Conditions. Masonry, mortar, and epoxy adhesives shall not be placed when weather conditions detrimentally affect the quality of the finished product. No masonry or mortar shall be placed when the air temperature is below 40 degrees F in the shade. When air temperature is likely to exceed 90 degrees F masonry and mortar shall have a temperature not exceeding 90 degrees F when deposited. Materials to be used in the work shall be neither produced nor placed during periods of rain or other precipitation. Stop material placements, and protect all in-place material from exposure, during periods of rain or other precipitation. Masonry surfaces shall be cleaned only when air temperatures are above 40 degrees F and will remain so until masonry has dried out, but for not less than seven days after completion of the work.

4.3 Masonry Installation Conditions. Do not perform any masonry repointing unless air temperatures are between 40 degrees F and 95 degrees F and will remain so for at least 48 hours after completion of work. Phase repointing during hot weather by completing process on the shady side of the bridge or schedule installation of materials during cooler evening hours to prevent premature evaporation of the water from the mortar. Do not use frozen materials or materials mixed or coated with ice or frost. Do not lower the freezing point of mortar by the use of admixtures or anti-freeze agents. Do not add chlorides to the mortar. Prevent repointing mortar from staining the face of the masonry or other exposed surfaces. Immediately remove all repointing mortar that comes in contact with such surfaces. Cover partially completed work when work is not in progress. Protect sills, ledges and projections from mortar droppings. If the Contractor fails to protect against bridge damage as a result of work of this Section, such damage shall be the Contractor's responsibility. The Contractor shall restore damaged areas to the complete satisfaction of the Owner at no expense to the Owner. Do not apply products under conditions outside manufacturer's requirements, which include:

- c. Surfaces that are frozen; allow complete thawing prior to installation.
- d. Surface and air temperatures below 40 degrees F.
- e. Surface and air temperatures above 95 degrees F.
- f. When surface or air temperature is not expected to remain above 40 degrees F for at least 48 hours after application.
- g. Wind conditions that may blow materials onto surfaces not intended to be treated.

VI. SPECIAL NOTE FOR MASONRY PATCHING REPAIRS

1.0 DESCRIPTION. Perform all work in accordance with the Kentucky Transportation Cabinet, Department of Highway's current Standard Specifications for Road and Bridge Construction and applicable Supplemental Specifications, the Standard Drawings, this Note, the Special Note for Masonry Repairs, the Special Note for Repointing, and the attached detail drawings. Section references are to the Standard Specifications. This note is for the patching of masonry surfaces. Dutchman and crack repairs are addressed in separate notes.

This work consists of the following: (1) Furnish all labor, materials, tools, and equipment; (2) Provide safe access to the bridge substructure, spandrel walls, and railings in accordance with Section 107.01.01, for the Engineer to sound possible repair areas and for workers to complete the construction; (3) Remove the deteriorated masonry; (4) Brush clean and prepare the surfaces for patching; (5) Apply the repair mortar; (6) Finish the repaired surface; (7) Maintain and control traffic; (8) Any other work specified as part of this contract.

2.0 MATERIALS.

2.1 Masonry Patching Repair Mortar. This material shall be a single-component, cementitious mortar designed for the restoration of limestone. Grout compounds must adhere to and match the stone as closely as possible, not only in appearance, color, texture, and tooling, but also in physical properties. Jahn M70 Restoration Mortar or an approved equal as determined by the Advisory Committee may be used.

2.2 Quality Assurance Sampling, Testing, and Acceptance. See Special Note for Masonry Repairs.

3.0 CONSTRUCTION. All areas involved in the work shall be inspected by the Contractor to establish the extent of work, access, and need for protection of surrounding construction, landscaping, etc. If conditions are not as expected, notify the Engineer immediately for direction. Using the attached detail drawings, and as directed by the Engineer, identify areas to receive patch repairs.

3.1 Restoration Mock-up. Perform a patch repair mock-up in accordance with the Special Note for Masonry Repairs. Do not proceed with other patch repairs until approved by the Engineer.

3.2 Site Preparation. Remove all loose mortar and masonry prior to installation of the repair. Sound masonry with a hammer to verify its integrity. For cracks or spalled areas larger than $\frac{9}{16}$ inch wide, use the Masonry Patching Repair Mortar for repairs. For smaller cracks, use the repair grout for repairs in accordance with the Special Note for Masonry Crack Repairs.

3.3 Mixing. Prepare the adhesive/grout in accordance with the manufacturer's recommendations.

3.4 Installation. Pre-wet the repair areas immediately prior to installation. Apply the masonry repair in accordance with the Manufacturer’s specifications at least to the limits indicated in the Plans or as directed by the Engineer. The masonry repair shall match the quality, color, pattern, and texture of the existing stone to the greatest extent possible.

3.5 Finishing. The finishing and texturing shall conceal bond lines between the repaired area and adjacent surfaces. The texturing shall provide replication of all surface details, including tooling and machine marks. Use low-impact energy type equipment in finishing and texturing, which will not weaken the patch or damage the patch bond and the adjacent masonry.

4.0 MEASUREMENT. The Department will measure the quantity of Masonry Patching Repair by the cubic feet of repair. The Department will not measure preparation of the site for the Engineer’s access or removal and reapplication of repairs that do not satisfy the Engineer’s approval for color for payment.

5.0 PAYMENT. Payment at the contract unit price per square foot is full compensation for all labor, access, equipment, and materials for the restoration mock-up, surface preparation, and furnishing, installing the patch repair mortar, finishing the repair surface, and repointing as needed around the patching repair.

The Department will make payment for the completed and accepted quantities under the following:

<u>Code</u>	<u>Pay Item</u>	<u>Pay Unit</u>
--	Concrete Patching Repair – Masonry Patching Repair	Square Foot

VII. SPECIAL NOTE FOR MASONRY CRACK REPAIRS

1.0 DESCRIPTION. Perform all work in accordance with the Kentucky Transportation Cabinet, Department of Highway's current Standard Specifications for Road and Bridge Construction and applicable Supplemental Specifications, the Standard Drawings, this Note, the Special Note for Masonry Repairs, the Special Note for Repointing, and the attached detail drawings. Section references are to the Standard Specifications. This note is for the crack repairs of masonry surfaces. Dutchman and patching repairs are addressed in separate notes.

This work consists of the following: (1) Furnish all labor, materials, tools, and equipment; (2) Provide safe access to the bridge substructure, spandrel walls, and railings in accordance with Section 107.01.01, for the Engineer to sound possible repair areas and for workers to complete the construction; (3) Remove the deteriorated masonry; (4) Brush clean and prepare the surfaces for patching; (5) Apply the injection grout; (6) Finish the repaired surface; (7) Maintain and control traffic; (8) Any other work specified as part of this contract.

2.0 MATERIALS.

2.1 Crack Repair Grout Type A. This material shall be a single-component, premixed cementitious injection grout that contains no corrosive constituents. Grout compounds must adhere to and match the stone as closely as possible, not only in appearance, color, texture, and tooling, but also in physical properties in accordance with the Special Note for Masonry Repairs. Jahn M30 Micro Injection Adhesive or an approved equal as determined by the Department's Division of Materials may be used.

2.2 Crack Repair Grout Type B. This material shall be a single-component, premixed cementitious injection grout that contains any acrylic, latex, or other synthetic polymer bonding agent or additives. Grout compounds must adhere to and match the stone as closely as possible, not only in appearance, color, texture, and tooling, but also in physical properties in accordance with the Special Note for Masonry Repairs. Jahn M40 Crack and Void Injection Grout or an approved equal as determined by the Department's Division of Materials may be used.

2.3 Quality Assurance Sampling, Testing, and Acceptance. See Special Note for Masonry Repairs.

3.0 CONSTRUCTION. All areas involved in the work shall be inspected by the Contractor to establish the extent of work, access, and need for protection of surrounding construction, landscaping, etc. If conditions are not as expected, notify the Engineer immediately for direction. Using the attached detail drawings, and as directed by the Engineer, identify areas to receive crack repairs.

3.1 Restoration Mock-up. Perform a crack repair mock-up in accordance with the Special Note for Masonry Repairs. Do not proceed with repairs until approved by the Engineer.

3.2 Site Preparation. Remove all loose mortar and masonry prior to installation of the repair. Sound masonry with a hammer to verify its integrity. For hairline cracks up to cracks $\frac{3}{16}$ inch wide, use Injection Grout Type A for repairs. For $\frac{3}{16}$ inch to $\frac{9}{16}$ inch wide cracks, use Injection Grout Type B for repairs. For larger cracks or spalled areas, use the repair mortar for repairs in accordance with the Special Note for Masonry Patching Repairs.

Drill a series of injection ports per the manufacturer's recommendations.

Wash the surface and interior of the crack using clean water to remove all dust, loose or deleterious material, which could prevent proper flow and/or adhesion, compromising the integrity of the cured injection grout.

3.3 Mixing. Prepare the adhesive/grout in accordance with the manufacturer's recommendations.

3.4 Installation. Install the grout in accordance with the manufacturer's recommendations at least to the limits indicated in the Plans or as directed by the Engineer. The masonry repair shall match the quality, color, pattern, and texture of the existing stone to the greatest extent possible.

3.5 Finishing. Remove plugs after 24 to 48 hours and repair the ports and the crack surface using repair mortar in accordance with the Special Note for Masonry Patching Repairs.

4.0 MEASUREMENT. The Department will measure the quantity of Masonry Crack Repair by the linear foot. The Department will not measure preparation of the site for the Engineer's access or removal and reapplication of repairs that do not satisfy the Engineer's approval (under recommendation of the Advisory Committee as defined in the General Notes) for color for payment and will consider them incidental to the Masonry Crack Repair.

5.0 PAYMENT. Payment at the contract unit price per linear foot is full compensation for all labor, access, equipment, and materials for the restoration mock-up, surface preparation, and furnishing, installing the crack repair adhesive/grout, finishing the crack repair surface, and repointing as needed around the crack repair.

The Department will make payment for the completed and accepted quantities under the following:

<u>Code</u>	<u>Pay Item</u>	<u>Pay Unit</u>
24824EC	Masonry Crack Repair	Linear Foot

VIII. SPECIAL NOTE FOR REPOINTING

1.0 DESCRIPTION. Perform all work in accordance with the Kentucky Transportation Cabinet, Department of Highway's current Standard Specifications for Road and Bridge Construction and applicable Supplemental Specifications, the Standard Drawings, this Note, the Special Note for Masonry Repairs, and the attached detail drawings. Section references are to the Standard Specifications.

This work consists of the following: (1) Furnish all labor, materials, tools, and equipment; (2) Provide safe access to the bridge substructure, spandrel walls, and railings in accordance with Section 107.01.01, for workers to complete the construction; (3) Analyze original mortar; (4) Remove the deteriorated pointing mortar; (5) Brush clean and prepare the surfaces for patching; (6) Place the pointing mortar; (7) Maintain and control traffic; (8) Any other work specified as part of this contract.

2.0 MATERIALS.

2.1 Pointing Mortar. This material shall be a single-component, cementitious, mineral based pointing mortar specifically formulated for the restoration of mortar joints. Grout compounds must adhere to the stone and match the existing mortar as closely as possible, not only in appearance, color, texture, and tooling, but also in physical properties. See the Special Note for Masonry Repairs.

2.2 Quality Assurance Sampling, Testing, and Acceptance. See Special Note for Masonry Repairs.

3.0 CONSTRUCTION. All areas involved in the work shall be inspected by the Contractor to establish the extent of work, access, and need for protection of surrounding construction, landscaping, etc. If conditions are not as expected, notify the Engineer immediately for direction. Using the attached detail drawings, and as directed by the Engineer, identify areas to receive repointing repairs.

3.1 Restoration Mock-up. Perform a repointing repair mock-up in accordance with the Special Note for Masonry Repairs. Do not proceed with other repointing repairs until approved by the Engineer.

3.2 Site Preparation. Existing mortar shall be removed to a minimum depth of 2 ½ times the width of the joint. All loose and deteriorated mortar must be removed, even if the recommended depth is exceeded. The mortar will only be removed using hand tools (i.e. hammer and chisel).

3.3 Reset Displaced Stones. If shown on the detail drawings, reset the stone masonry to match the areas immediately adjacent to the repair area. Care is to be taken to avoid damaging the surrounding existing stone that is in good condition. Any damage to the existing stone masonry beyond the limits of repair is to be repaired to the satisfaction

of the Engineer at no additional cost the Cabinet. Any loose stone removed, which is in good condition, can be reused in the repair area or elsewhere.

After removing mortar, all loose particles should be removed from the joint by brushing, pressurized water, or compressed air. Dampen all the joint components prior to pointing. Payment for resetting displaced stones is incidental to "Repointing".

3.4 Mixing. Prepare mortar in accordance with the manufacturer's recommendations.

3.5 Installation. Install per the manufacturer's recommendations.

3.6 Finishing. After mortar joint has set, tool to the desired finish as directed by the Engineer. Do not allow the mortar to harden before tooling. Cure the mortar according to the manufacturer's recommendations.

4.0 MEASUREMENT. The Department will measure the quantity of Repointing by the linear foot. The Department will not measure preparation of the site for the Engineer's access or removal and reapplication of repairs that do not satisfy the Engineer's approval (under recommendation of the Advisory Committee as defined in the General Notes) for color, quality, and workmanship for payment.

5.0 PAYMENT. Payment at the contract unit price per linear foot is full compensation for all labor, access, equipment, and materials for the restoration mock-up, surface preparation, resetting displaced stones, and furnishing, installing, and finishing the mortar. Repointing needed for Masonry Patching Repairs, Masonry Crack Repairs, Dutchman Repairs, or Stone Replacement shall be considered incidental to the work being performed. Payment for the item Repointing shall cover any additional repointing, as directed by the Engineer, in areas/locations outside of those covered by the aforementioned work items.

The Department will make payment for the completed and accepted quantities under the following:

<u>Code</u>	<u>Pay Item</u>	<u>Pay Unit</u>
24827EC	Repointing	Linear Foot

IX. SPECIAL NOTE FOR DUTCHMAN REPAIRS

1.0 DESCRIPTION. Perform all work in accordance with the Kentucky Transportation Cabinet, Department of Highway's current Standard Specifications for Road and Bridge Construction and applicable Supplemental Specifications, the Standard Drawings, this Note, the Special Note for Masonry Repairs, the Special Note for Repointing, and the attached detail drawings. Section references are to the Standard Specifications.

This work consists of the following: (1) Furnish all labor, materials, tools, and equipment; (2) Provide safe access to the bridge substructure, spandrel walls, and railings in accordance with Section 107.01.01, for workers to complete the construction; (3) Remove the deteriorated masonry; (4) Brush clean and prepare the surfaces; (5) Install metal attachments for setting stone; (6) Apply the casting mortar; (7) Install Dutchman stone; (8) Maintain and control traffic; (9) Any other work specified as part of this contract.

2.0 MATERIALS.

2.1 Replacement Stone. Replacement stone selected shall match in type, color, shape, size, texture and finish-profile the appearance of the existing historic stone units. It is believed that the Bridge 8 contains Indiana limestone while Bridge 9 has Buff Bedford limestone

2.1 Casting Mortar. This material shall be a single-component, dry-pack mortar that contains no latex or acrylic bonding agents or additives. Mortar must adhere to and match the stone as closely as possible, not only in appearance, but also in physical properties in accordance with the Special Note for Masonry Repairs.

2.2 Metal Attachments. All wire pins, anchors, and bars shall be stainless steel, Type 302 and 304. Provide anchors as follows:

- a. 1/8" diameter round stock, stainless steel wire with turned-up ends for small veneers.
- b. 3/8" diameter round stock, stainless steel rod for direct pinning and drop dowels.
- c. 1" wide, 1/8" thick, stainless steel, flat strap anchors for larger panels.

2.3 Type IV Epoxy Resin. Use either Category I or II. See Section 826.

2.4 Quality Assurance Sampling, Testing, and Acceptance. See Special Note for Masonry Repairs.

3.0 CONSTRUCTION. All areas involved in the work shall be inspected by the Contractor to establish the extent of work, access, and need for protection of surrounding construction, landscaping, etc. If conditions are not as expected, notify the Engineer immediately for direction. Using the attached detail drawings, and as directed by the Engineer, identify areas to receive Dutchman repairs. All work should be in accordance with ASTM C1722, *Standard Guide for Repair and Restoration of Dimension Stone*, except as amended by these notes and detail drawings.

3.1 Restoration Mock-up. Perform a Dutchman repair mock-up in accordance with the Special Note for Masonry Repairs. Do not proceed with other Dutchman repairs until approved by the Engineer.

3.2 Site Preparation. Sound masonry with a hammer to verify its integrity. Remove all unsound, weak, damaged, and loose mortar and masonry prior to installation of the repair. Before removing any deteriorated masonry units, establish bonding patterns, levels and coursings. Remove masonry that has deteriorated or is damaged beyond repair, as determined through investigation and evaluation. Cut existing spalls to form rectangular losses with square corners, minimum 2” thickness. Removed stone, which is in good condition, is acceptable to be reused for Dutchman repairs.

3.3 Erection, Installation, Application. Mortar shall be mixed to a workable consistency and applied to the entire repair area, on all sides. The Dutchman shall be fastened with stainless steel wire, pins, and anchors and epoxy as necessary to facilitate mechanical locking and to prevent possible slippage of the stone. The metal fasteners shall be positioned without weakening the stone in any way. The quantity of individual attachments shall not be less than two attachments for small Dutchman repairs and one attachment every two square feet for larger panels. All attachments shall be fastened by mechanical locking, in addition to appropriate adhesives and mortars.

The joints between new and old work shall be finished to match the color and texture of the mortar. See the Special Note for Repointing if it is necessary to match up the new and old mortar. The surface of the new stone shall be dressed to resemble the appearance of the adjoining stone by an approved method. All surface dressing of new work shall be done before the stone is set.

4.0 MEASUREMENT. The Department will measure the quantity of Dutchman Repairs by the square feet of surface covered. The Department will not measure preparation of the site for the Engineer’s access or removal and reapplication of repairs that do not satisfy the Engineer’s approval (under recommendation of the Advisory Committee as defined in the General Notes) for color for payment and will consider them incidental to the Dutchman Repair.

5.0 PAYMENT. Payment at the contract unit price per square foot is full compensation for all labor, access, equipment, and materials for the restoration mock-up, surface preparation, furnishing and installing the replacement stone, casting mortar, metal attachments, and repointing as needed around the repair.

The Department will make payment for the completed and accepted quantities under the following:

<u>Code</u>	<u>Pay Item</u>	<u>Pay Unit</u>
24823EC	Dutchman Repair	Square Foot

X. SPECIAL NOTE FOR STONE REPLACEMENT

1.0 DESCRIPTION. Perform all work in accordance with the Kentucky Transportation Cabinet, Department of Highway's current Standard Specifications for Road and Bridge Construction and applicable Supplemental Specifications, the Standard Drawings, this Note, the Special Note for Masonry Repairs, the Special Note for Repointing, and the attached detail drawings. Section references are to the Standard Specifications.

This work consists of the following: (1) Furnish all labor, materials, tools, and equipment; (2) Provide safe access to the bridge substructure, spandrel walls, and railings in accordance with Section 107.01.01, for workers to complete the construction; (3) Remove the deteriorated masonry; (4) Brush clean and prepare the surfaces; (5) Install metal attachments for setting stone; (6) Apply the casting mortar; (7) Install Replacement Stone; (8) Removing and resetting the existing railings to a plumb orientation, (8) Maintain and control traffic; (9) Any other work specified as part of this contract.

2.0 MATERIALS.

2.1 Replacement Stone. Replacement stone selected shall match in type, color, shape, size, texture and finish-profile the appearance of the existing historic stone units. The compressive strength of the replacement stones should closely match the compressive strength of existing stones. Verify the strength of proposed and existing stones using ASTM C170/C170M. It is believed that the bridge contains Indiana limestone.

2.1 Casting Mortar. This material shall be a single-component, dry-pack mortar that contains no latex or acrylic bonding agents or additives. Match the appearance and physical properties of the mortar, as described in the Special Note for Masonry Repairs.

2.2 Metal Attachments. All wire pins, anchors, and bars shall be stainless steel, Type 302 and 304. Provide anchors as follows:

- a. 1/8" diameter round stock, stainless steel wire with turned-up ends for small veneers.
- b. 3/8" diameter round stock, stainless steel rod for direct pinning and drop dowels.
- c. 1" wide, 1/8" thick, stainless steel, flat strap anchors for larger panels.

2.3 Type IV Epoxy Resin. Use either Category I or II. See Section 826.

2.4 Quality Assurance Sampling, Testing, and Acceptance. See Special Note for Masonry Repairs.

3.0 CONSTRUCTION. All areas involved in the work shall be inspected by the Contractor to establish the extent of work, access, and need for protection of surrounding construction, landscaping, etc. If conditions are not as expected, notify the Engineer immediately for direction. Using the attached detail drawings, and as directed by the Engineer, identify areas to receive Replacement Stones. All work should be in accordance with ASTM C1722, *Standard*

Guide for Repair and Restoration of Dimension Stone, except as amended by these notes and detail drawings.

3.1 Site Preparation. Sound masonry with a hammer to verify its integrity. Remove all unsound, weak, damaged, and loose mortar and masonry prior to installation of the repair. Before removing any deteriorated masonry units, establish bonding patterns, levels and coursings. Dismantle the existing stone railings and spandrel walls to the extents necessary to access stones to be replaced as shown in the detail drawings. Match-mark removed stones for re-assembly. Stockpile the dismantled stones in an acceptable location as directed by the Engineer. The Contractor is responsible for the design and construction of all temporary supports during construction. Removed stone, which is in good condition, is acceptable to be reused.

3.2 Urn Replacement. Where specified on the plans, the contractor shall replicate the existing urns to their original material, shape, size, texture, and appearance.

3.2 Erection, Installation, Application. Mortar for setting limestone replacement stones shall be mixed to a workable consistency and applied to the entire repair area, on all sides. The replacement stones shall be fastened with stainless steel wire, pins, and anchors and epoxy as necessary to facilitate mechanical locking and to prevent possible slippage of the stone. The metal fasteners shall be positioned without weakening the stone in any way. The quantity of individual attachments shall not be less than two attachments for small replacement stones, and one attachment every two square feet for larger panels. All attachments shall be fastened by mechanical locking, in addition to appropriate adhesives and mortars.

The joints between new and old work shall be finished to match the color and texture of the mortar. See the Special Note for Repointing if it is necessary to match up the new and old mortar. The surface of the new stone shall be dressed to resemble the appearance of the adjoining stone by an approved method. All surface dressing of new work shall be done before the stone is set.

Reset the stone masonry spandrel walls and railings to match the wall sections immediately adjacent to them and ensure that they are rebuilt plumb.

4.0 MEASUREMENT. The Department will measure the quantity of Stone Masonry Veneer by the square feet of surface covered (or the largest face only where corner units are replaced). The Department will not measure preparation of the site for the Engineer's access or removal and reapplication of repairs that do not satisfy the Engineer's approval (under recommendation of the Advisory Committee as defined in the General Notes) for color for payment and will consider them incidental to the Stone Masonry Veneer.

The Department will measure the quantity of "Remove and Reset – Decorative Railing" by the linear foot of railing removed and reset.

5.0 PAYMENT. Payment at the contract unit price per square foot is full compensation for all labor, access, temporary supports, equipment, and materials for the restoration mock-up, surface preparation, furnishing and installing the replacement stone, casting mortar, metal attachments, and repointing as needed around the repair.

The Department will make payment for the completed and accepted quantities under the following:

<u>Code</u>	<u>Pay Item</u>	<u>Pay Unit</u>
08004	Stone Masonry Veneer	Square Foot
24731EC	Remove and Reset – Decorative Urns	Each
24731EC	Remove and Reset – Decorative Railing	Linear Feet

XI. SPECIAL NOTE FOR CONCRETE ARCH WATERPROOFING

1.0 DESCRIPTION. Perform all work in accordance with the Kentucky Transportation Cabinet, Department of Highway's current Standard Specifications for Road and Bridge Construction and applicable Supplemental Specifications, the Standard Drawings, this Note, and the attached detail drawings. Section references are to the Standard Specifications.

This work consists of: (1) Furnish all labor, materials, tools, and equipment; (2) Surveying; (3) Provide safe access to the bridge substructure and spandrel walls, in accordance with Section 107.01.01, for the Engineer to sound possible repair areas and for workers to complete the construction; (4) Remove the existing bridge overlay and backfill; (5) Prepare and patch the arch surface; (6) Apply the waterproofing membrane and protection board; (7) Place and compact backfill; (8) Erosion Control; (9) Apply the asphalt surface; (10) Maintain and control traffic; and (11) Any other work specified as part of this contract.

2.0 MATERIALS.

2.1 Waterproofing Membrane. Use a sprayable/rollable elastomeric polyurethane waterproofing membrane, MasterSeal HLM 5000 or approved equivalent.

2.2 Class "A" Concrete for Curbs. See Section 601, except use a historic mix to replicate the textures, color, and appearance of the existing concrete surfaces.

2.3 Waterproofing Membrane Protection. Provide an asphalt based protection board capable of protecting waterproofing membrane from penetration by sharp aggregate during backfilling. The protection board shall contain a multi-ply semi-rigid core formed between two outside layers of reinforced mats, manufactured in accordance with ASTM D 6506. It shall be compatible with the Waterproofing Membrane and capable of withstanding vehicular loading.

2.4 Flowable Fill. Use Flowable Fill for Bridge End Bent Backfill. See Section 601.03.03B.

2.5 Structure Granular Backfill. See Section 805.11.

2.6 Crushed Stone Base. See Section 805.06.

2.7 Geotextile Fabric. Use Type IV Geotextile Fabric. See Section 843.

2.8 Class 2 Asphalt Base 1.00D PG 64-22. This material shall be in accordance with the Standard Specifications.

2.9 Class 2 Asphalt Surface 0.38D PG 64-22. This material shall be in accordance with the Standard Specifications.

3.0 EQUIPMENT. Only lightweight construction equipment should be used on or around the arch.

4.0 CONSTRUCTION. The Contractor shall bear full responsibility and expense for any and all damage to the structure, should such damage result from the Contractor's actions.

4.1 Survey. Prior to beginning work, survey the existing roadway profile, grade and cross slopes so that the roadway can be reconstructed to match its existing condition. Payment for surveying prior to beginning work will be incidental to "Staking."

4.2 Asphalt and Backfill Removal. Remove the asphalt and backfill material to expose the concrete arch barrel within the required slopes and to the depth required. Use hand-tools when working within three feet of the arch or spandrel walls. Remove and dispose material away from the job site in a manner approved by the Engineer. The Contractor is responsible for temporarily supporting retained earth and structures, including the spandrel walls, as needed. The contractor is to safeguard and protect any tension ties and or counterforts that may be found which support the spandrel walls. As a precaution against introducing unbalanced stresses, remove the backfill concurrently on both sides of the arch. Do not remove backfill below the top of footing. The elevation should not differ more than one foot at any time.

4.3 Concrete Patching Repair. Remove and replace areas of deteriorated concrete in the arch barrel in accordance with the Special Note for Concrete Patching Repair. For measurement and payment, see the Special Note for Concrete Patching Repair.

4.4 Surface Preparation. The entire surface area of the arch barrel extrados to be waterproofed shall be thoroughly cleaned by either air blasting or water blasting in accordance with the Special Note for Bridge Cleaning. If water blasting is used, the area shall be allowed to thoroughly dry prior to placing the membrane.

4.5 Waterproofing Membrane. Apply waterproofing as shown in the detail drawings. The waterproofing shall be applied as necessary to achieve 100% coverage of the bridge arch and shall be installed as recommended by the Manufacturer. Do not allow traffic or pedestrians on the waterproofing prior to backfilling.

4.6 Waterproofing Protection. The protection board shall be applied over the entire surface of the Waterproofing. Adhere the protection to the waterproofing using an approved adhesive. Install in accordance with the manufacturer's recommendations.

4.7 Drainage System. Drill 4" diameter weep hole drains as shown in the attached detail drawings. Apply epoxy over any cut steel reinforcement. Cover the weep holes with geotextile fabric as shown in the attached detail drawings. Install flowable fill in accordance with detailed drawings. Slope the fill towards the weep hole drains. No additional payment will be made for the installation of the weep holes or geotextile fabric as it is incidental to "Waterproofing Membrane".

4.8 Structure Granular Backfill. Backfill in accordance with the detail drawings, Section 603.03.04, and as directed by the Engineer immediately after the membrane protection is in place using care and caution to avoid damaging the membrane. Backfill should not be placed until the membrane and protection board are approved by the Engineer.

Place and compact backfill material in uniform horizontal lifts not exceeding one foot for stone and six inches for soil material. As a precaution against introducing unbalanced stresses, place and compact the backfill to the same elevation on both sides of arches before proceeding to the next lift. The elevation should not differ more than one foot at any time.

4.9 Erosion Control. The Contractor should seed or stabilize stream banks immediately upon completion of grading in accordance with the Special Note for Erosion Control.

4.10 Curbs. Where shown on the attached detail drawings, construct concrete curbs in accordance with Section 601.

4.11 Bridge Paving. Repave the bridge to match the existing profile, grade, and cross slopes or as directed by the Engineer. Stripe the bridge to match existing.

5.0 MEASUREMENT.

5.1 Staking. Staking will be measured as lump sum in accordance with Section 201.

5.2 Remove Pavement. This item will be measured in square yards.

5.3 Waterproofing Membrane. This material shall be measured in square yards calculated from the length of the arch plus one foot on each approach times the width of the bridge railing to railing plus six inches up each spandrel wall. $A=(L + 2') \times (W + 1')$. This calculated area will be the area measured for payment and waste will not be measured for payment.

5.4 Flowable Fill. This material shall be measured in cubic yards.

5.5 Structure Granular Backfill. This material shall be measured in cubic yards.

5.6 Crushed Stone Base. See Section 302.04.

5.7 Repair Concrete Curb. This material shall be measured in linear feet.

5.8 Class 2 Asphalt Base 1.00D PG 64-22. This material will be measured in accordance with the Standard Specifications.

5.9 Class 2 Asphalt Surface 0.38D PG 64-22. This material will be measured in accordance with the Standard Specifications.

6.0 PAYMENT.

6.1 Staking. See Section 201.05.

6.2 Remove Pavement. Payment at the contract unit price shall be full compensation for all labor, equipment and materials for pavement removal, removal of existing backfill including any and all obstructions found, and drill through the arch rib for the installation of drainage.

6.3 Waterproofing Membrane. Payment of contract unit price per square yard shall be full compensation for all labor, equipment and materials for surface preparation, furnishing the waterproofing, protection board, geotextile fabric and attachments, and weep holes, in accordance with the Manufacturer's recommendations and this note, including the cost to salvage and reinstall signs.

6.4 Flowable Fill. Payment of contract unit price per cubic yard shall be full compensation for all labor, equipment and materials for furnishing and installing the flowable fill.

6.5 Structure Granular Backfill. Payment of contract unit price per cubic yard shall be full compensation for all labor, equipment and materials for furnishing and installing the structure granular backfill, and geotextile fabric.

6.6 Crushed Stone Base. Payment of contract unit price per ton shall be full compensation for all labor, equipment and materials for furnishing and installing the crushed stone base.

6.7 Repair Concrete Curb. Payment of contract unit price per foot shall be full compensation for all labor, equipment and materials for furnishing and installing the concrete curb.

6.8 Class 2 Asphalt Base 1.00D PG 64-22. Payment for this material will be made in accordance with the Standard Specifications.

6.9 Class 2 Asphalt Surface 0.38B PG 64-22. Payment for this material will be made in accordance with the Standard Specifications.

The Department will consider payment as full compensation for all work required by this note and the attached detail drawings.

<u>Code</u>	<u>Pay Item</u>	<u>Pay Unit</u>
00003	Crushed Stone Base	Ton
00212	Class 2 Asphalt Base 1.00D PG 64-22	Ton
00307	Class 2 Asphalt Surface 0.38B PG64-22	Ton
02091	Remove Pavement	Square Yard
02220	Flowable Fill	Cubic Yard
02231	Structure Granular Backfill	Cubic Yard
02726	Staking	Lump Sum
03250	Waterproofing Membrane	Square Yard
03302	Repair Concrete Curb	Linear Foot
06540	Pave Striping-Thermo-4 in W	Linear Foot
06541	Pave Striping-Thermo-4 in Y	Linear Foot

XII. SPECIAL NOTE FOR ARCH LINING

1.0 DESCRIPTION. Perform all work in accordance with the Kentucky Transportation Cabinet, Department of Highway's current Standard Specifications for Road and Bridge Construction and applicable Supplemental Specifications, the Standard Drawings, this Note, and the attached detail drawings. Section references are to the Standard Specifications.

This work consists of the following: (1) Furnish all labor, materials, tools, and equipment; (2) Provide safe access to the bridge substructure and arch barrel, in accordance with Section 107.01.01, for the Engineer to sound possible repair areas and for workers to complete the construction; (3) Remove the deteriorated concrete; (4) Blast clean and prepare the surfaces for lining; (5) Install adhesive anchors and/or steel reinforcement; (6) Prime the areas immediately prior to lining; (7) Apply the lining; (8) Finish the lining surface; (9) Maintain and control traffic; (10) Any other work specified as part of this contract.

2.0 MATERIALS.

2.1 Arch Lining. The lining shall be a historic cementitious mix that matches the quality, color, pattern, and texture of the existing concrete. The lining shall have a minimum 7 compressive strength of 4,000 psi. Allow the lining to cure for at least three days before obtaining the Engineer's approval (under recommendation of the Advisory Committee as defined in the General Notes) for a color match.

2.2 Welded Steel Wire Fabric (WWF). Conform to Section 811.

2.3 Hook Fasteners. Use commercial grade galvanized hook fasteners. Minimum 3/16" diameter.

2.4 Steel Reinforcement. Use Grade 60. See Section 602

3.0 CONSTRUCTION.

3.1 Restoration Mock-up. Submit the restoration methods and materials selected for approval before work starts. No material shall be used in the work until the mock-ups and the represented material and workmanship have been approved. Materials shall be submitted and approved prior to the creation of mock-ups. The placement, size, and location of mock-ups will be in a less visible area of the bridge as directed by the Engineer. The Contractor must gain approval from the Engineer on their proposed methods, materials, and mock-up before beginning work. The Engineer will consult with the Advisory Committee (as defined in the General Notes) before making a decision. No additional payment will be made for this sample.

Mock-ups must demonstrate the methods and quality of workmanship to be performed in each treatment.

- a. Prepare mock-ups on existing concrete under the same weather conditions expected during the remainder of the work.

- b. Throughout restoration, retain approved mock-up panels in undisturbed condition, suitably marked, as a standard for judging completed work.
- c. Review manufacturer's product data sheets to determine suitability of each product for each surface.
- d. Apply products using manufacturer-approved application methods, determining actual requirements for application.
- e. Obtain approval as to the preservation treatment approach, design, and workmanship to include, but not limited to the verification of all material applications and finishes as specified to the requirements of color, texture, profiles, and finishes before proceeding with work.
- f. Mock-ups: May be performed on inconspicuous sections of actual construction
 1. Location and number of mock-ups as directed by the Engineer.
 2. Size: two feet by two feet or as appropriate for the repair specified.
 3. Repair unacceptable work.

3.2 Remove Deteriorated Concrete. Prior to beginning the concrete repairs, provide safe access to the substructure and arch barrel, in accordance with Section 107.01.01, for the Engineer to sound possible repair areas.

Remove specified areas of spalled, deteriorated, and delaminated concrete as shown on the attached detail drawings and/or as directed by the Engineer. Sounding shall be used to locate delaminated areas. Care shall be exercised not to damage areas of sound concrete. All areas of deteriorated concrete found should be repaired as part of this work. Concrete removal shall be accomplished by chipping with hand picks, chisels or light duty pneumatic or electric chipping hammers (not to exceed 15 lbs.). If sound concrete is encountered before existing reinforcing steel is exposed, the surface shall be repaired without further removal of the concrete. Precautions shall be exercised to protect the underlying sound material. Also ensure concrete removal extends at least three-quarters (3/4) inch beyond any exposed steel. A minimum of 1-inch in length of bar shall be exposed. Dispose of all removed material entirely away from the job site or as directed by the Engineer. The perimeter of all areas where concrete is removed shall be tapered at an approximately 45° angle, except that the outer edges of all chipped areas shall be saw cut to minimum depth of 3/4 inch to prevent feather edging unless otherwise approved by the Engineer.

Extreme care shall be taken when removing the existing spalled or delaminated concrete so as not to damage the existing reinforcing steel. Do not cut or remove the existing reinforcing steel. Repair or replace any damaged steel reinforcement as directed by the Engineer at no additional cost to the Department. Ensure that all exposed steel reinforcement is tied in accordance with Section 602.03.04.

After all deteriorated concrete has been removed; the repair surface shall be prepared by abrasive blast cleaning. Abrasive blast cleaning shall remove all fractured surface concrete and all traces of any unsound material or contaminants such as oil, grease, dirt, slurry, or any materials which could interfere with the bond of freshly placed concrete.

The Contractor shall dispose all removed material in an approved site.

3.3 Steel Reinforcement. All corroded reinforcing steel exposed during concrete removal shall have corrosion products removed by abrasive grit blasting or wire brush whichever is more appropriate. Furnish for replacement, as directed by the Engineer, additional linear feet of steel reinforcing bars ½” diameter by 20-foot lengths. Place these bars in areas deemed by the Engineer to require additional reinforcement. Field cutting and bending is permitted. Payment will be made in accordance with Section 602.

Reinforcing steel displaying deep pitting or loss of more than 20 percent of cross-sectional area shall be removed and replaced. Such bars shall be placed in accordance with the recommendations of ACI 506R, Sections 5.4 and 5.5. In particular, bars shall not be bundled in lapped splices, but shall be placed such that the minimum spacing around each bar is three times the maximum aggregate size to allow for proper encapsulation with lining.

Intersecting reinforcing bars shall be tightly secured to each other using tie wire and adequately supported to minimize movement during concrete placement.

Welded wire fabric (WWF) shall be provided as shown on the attached sketches and at each repair area larger than 1 square foot if the depth of the repair exceeds 3 inches from the original dimension of the repaired member. Sheets of adjoining WWF shall be lapped by at least one and one-half spaces at all intersections, in both directions, and be securely fastened. WWF fabric shall be supported no closer than ½ inch to the prepared concrete surface and shall have a minimum concrete cover of 1.5 inches.

WWF shall be fastened to preset anchors on a grid not more than 12 inches square. Large knots of tie wire which could result in sand pockets and voids during patching shall be avoided.

3.4 Hook Fasteners. Hook fasteners shall be positioned at the spacing as stated above or as directed by the Engineer. Any given area shall have a minimum of four anchors. The WWF shall not move or deform excessively during concrete patching. Maximum hook fastener spacing shall not exceed 2 feet on a grid pattern over the entire repair area. Hook fasteners shall be of commercial grade galvanized steel with a minimum diameter of 3/16”. They may be mechanically set or grouted, as approved by the Engineer. The Department will randomly select hook fasteners to be tested to verify pullout force is sufficient. If any anchors fail to meet the minimum acceptable pullout value, corrective measures shall be taken by the Contractor and further testing will be conducted.

3.5 Prepare Concrete Surfaces for Lining. Prepare concrete surfaces to be lined in accordance with Section 510.03.01.

3.6 Arch Lining. The cementitious material used must be approved by the Engineer. The Engineer shall approve the Contractor’s mix design and method of placing and consolidating the lining prior to the beginning of this operation. Place and finish the lining in accordance with the manufacturer’s recommendations, as shown on the attached detail drawings, or as directed by the Engineer. WWF for the lining may be placed continuously across the arch, however, to facilitate adequate consolidation, the lining shall be formed and poured in the sequence shown in the attached detail drawings.

3.7 Finishing/Curing. Cure and finish in accordance with the manufacturer's recommendations and to match the texture of the existing concrete. On completion of finishing operation, lining shall immediately be prevented from drying out and cracking by fogging, wetting, and/or any appropriate method approved by the Engineer. Curing shall continue for duration recommended by the product manufacturer.

4.0 MEASUREMENT.

4.1 Concrete Patching Repair. The Department will measure the quantity in cubic feet.

4.2 Steel Reinforcement-Epoxy Coated. The Department will measure the quantity in pounds, including the pounds of welded wire fabric. Steel reinforcement will not be measured for payment, but shall be considered incidental to "Concrete Patching Repair".

4.3 Welded Wire Fabric & Hook Fasteners. Welded Wire Fabric and Hook Fasteners will not be measured for payment, but shall be considered incidental to "Concrete Patching Repair".

5.0 PAYMENT.

5.1 Concrete Patching Repair. Payment at the contract unit price per cubic feet is full compensation for removal of deteriorated concrete, preparation of the concrete surface, application of the cementitious lining, mock-ups, installation of adhesive anchors, and all incidental items necessary to complete the work in accordance with this Note and as shown on the attached detail drawings. Final payment for "Concrete Patching Repair" will be the field-measured quantity of lining completed in accordance with this Note and as designated by the Engineer.

The Department will consider payment as full compensation for all work required by this note and the attached detail drawings.

<u>Code</u>	<u>Pay Item</u>	<u>Pay Unit</u>
23428EC	Concrete Patching Repair	Cubic Feet

XIII. SPECIAL NOTE FOR CONCRETE SEALING

1.0 DESCRIPTION. Perform all work in accordance with the Kentucky Transportation Cabinet, Department of Highway's current Standard Specifications for Road and Bridge Construction and applicable Supplemental Specifications, the Standard Drawings, this Note, and the attached detail drawings. Section references are to the Standard Specifications.

This work consists of the following: (1) Furnish all labor, materials, tools, and equipment; (2) Provide safe access to the bridge substructure, spandrel walls, and railings in accordance with Section 107.01.01, for workers to complete the construction; (3) Apply silane seal coat as directed and in accordance with the manufacturer's recommendations; (4) Maintain and control traffic; (5) Any other work specified as part of this contract.

2.0 MATERIALS.

2.1 Silane Sealer. The silane sealer shall be a clear coating intended for vertical and non-traffic bearing concrete surfaces, such as Sikagard 701W, or an approved equivalent.

3.0 CONSTRUCTION. All areas involved in the work shall be inspected by the Contractor to establish the extent of work, access, and need for protection of surrounding construction, landscaping, etc. If conditions are not as expected, notify the Engineer immediately for direction. Using the attached detail drawings, and as directed by the Engineer, identify areas to receive concrete sealing.

3.1 Site Preparation. Prepare concrete surfaces to be sealed in accordance with Section 510.03.01. Complete all concrete crack and patching repairs prior to sealing. Final blast cleaning shall be completed within twelve (12) hours prior to placement of the silane seal coat. Concrete must be sound, dry, and clean prior to placement of silane seal coat.

3.2 Testing. Test the silane sealant on an inconspicuous location. Do not proceed with sealing until approved by the Engineer.

3.3 Mixing. Prepare silane sealer in accordance with the manufacturer's recommendations.

3.4 Installation. Apply silane sealer in accordance with the manufacturer's recommendations.

4.0 MEASUREMENT. The Department will measure the quantity of Concrete Sealing by the square foot. The Department will not measure preparation of the site for the Engineer's access or removal and reapplication of repairs that do not satisfy the Engineer's approval (under recommendation of the Advisory Committee as defined in the General Notes) for color, quality, and workmanship for payment and will consider them incidental to the Concrete Sealing.

5.0 PAYMENT. Payment at the contract unit price per square foot is full compensation for all labor, access, equipment, and materials for the surface preparation, and furnishing and installing the sealer.

The Department will make payment for the completed and accepted quantities under the following:

<u>Code</u>	<u>Pay Item</u>	<u>Pay Unit</u>
23378EC	Concrete Sealing	Square Foot

Special Note for Bridge Demolition, Renovation and Asbestos Abatement

If the project includes any bridge demolition or renovation, the successful bidder is required to notify Kentucky Division for Air Quality (KDAQ) via filing of form (DEP 7036) a minimum of 10 days prior to commencement of any bridge demolition or renovation work.

Any available information regarding possible asbestos containing materials (ACM) on or within bridges to be affected by the project has been included in the bid documents. These are to be included with the Contractor's notification filed with the KDAQ. If not included in the bid documents, the Department will provide that information to the successful bidder for inclusion in the KDAQ notice as soon as possible. If there are no documents stating otherwise, the bidders should assume there are no asbestos containing materials that will in any way affect the work.



TRANSPORTATION CABINET

Frankfort, Kentucky 40622
www.transportation.ky.gov

Steven L. Beshear
Governor

Michael W. Hancock, P.E.
Secretary

Memorandum

To: Susan Oatman
CC: Tim Foreman
From: O'Dail Lawson
Environmental Scientist IV
Division of Environmental Analysis
Date: 4/10/2015
Re: Asbestos Inspection Report for Jefferson 05-1062

This report is prepared to accompany the 10-Day NOI for Demolition to the Division of Air Quality. Please include all pages with submittal.

Project and Structure Information

Project # Jefferson 05-1062

Bridge # 056C00033N

Location: Millvale Road over Middle Fork of Beargrass Creek (Bridge #8)

Description: There are no suspect materials on this structure.

Results

The inspection revealed that there is no suspect ACM materials; no abatement necessary



An Equal Opportunity Employer M/F/D

The EI Group, Inc.

This certifies that

Tilmon O'Dail Lawson

Student Address: 132 Old Fort Drive, Georgetown, Kentucky 40324

Has attended and satisfactorily passed an examination covering the contents of an EPA/AHERA approved course entitled

Asbestos Inspector Refresher (4-Hour) Training Course

7214880013
Certificate Number

7910
Social Security Number

August 15, 2014
Course Date

August 15, 2014
Exam Date

August 15, 2015
Expiration Date

Louisville, KY
Course Location

Berry E. Maxwell
Berry Maxwell, Training Manager



Keri Boddy
Keri Boddy, Principal Instructor

Keri Boddy
Keri Boddy, Exam Administrator



3240 Office Pointe Place, Suite 102
Louisville, KY 40220
888-372-5859

	KENTUCKY TRANSPORTATION CABINET Department of Highways DIVISION OF RIGHT OF WAY & UTILITIES	TC 62-226 Rev. 01/2016 Page 1 of 1
RIGHT OF WAY CERTIFICATION		

<input checked="" type="checkbox"/> Original	<input type="checkbox"/> Re-Certification	RIGHT OF WAY CERTIFICATION	
ITEM #	COUNTY	PROJECT # (STATE)	PROJECT # (FEDERAL)
04-10011.00	Hardin	FD04 047 2212 B00134N	
PROJECT DESCRIPTION			
ADDRESS DEFICIENCIES OF KY 2212 BRIDGE OVER PAWLEY CREEK. (047B00134N)			
<input checked="" type="checkbox"/> No Additional Right of Way Required			
Construction will be within the limits of the existing right of way. The right of way was acquired in accordance to FHWA regulations under the Uniform Relocation Assistance and Real Property Acquisitions Policy Act of 1970, as amended. No additional right of way or relocation assistance were required for this project.			
<input type="checkbox"/> Condition # 1 (Additional Right of Way Required and Cleared)			
All necessary right of way, including control of access rights when applicable, have been acquired including legal and physical possession. Trial or appeal of cases may be pending in court but legal possession has been obtained. There may be some improvements remaining on the right-of-way, but all occupants have vacated the lands and improvements, and KYTC has physical possession and the rights to remove, salvage, or demolish all improvements and enter on all land. Just Compensation has been paid or deposited with the court. All relocations have been relocated to decent, safe, and sanitary housing or that KYTC has made available to displaced persons adequate replacement housing in accordance with the provisions of the current FHWA directive.			
<input type="checkbox"/> Condition # 2 (Additional Right of Way Required with Exception)			
The right of way has not been fully acquired, the right to occupy and to use all rights-of-way required for the proper execution of the project has been acquired. Some parcels may be pending in court and on other parcels full legal possession has not been obtained, but right of entry has been obtained, the occupants of all lands and improvements have vacated, and KYTC has physical possession and right to remove, salvage, or demolish all improvements. Just Compensation has been paid or deposited with the court for most parcels. Just Compensation for all pending parcels will be paid or deposited with the court prior to AWARD of construction contract			
<input type="checkbox"/> Condition # 3 (Additional Right of Way Required with Exception)			
The acquisition or right of occupancy and use of a few remaining parcels are not complete and/or some parcels still have occupants. All remaining occupants have had replacement housing made available to them in accordance with 49 CFR 24.204. KYTC is hereby requesting authorization to advertise this project for bids and to proceed with bid letting even though the necessary right of way will not be fully acquired, and/or some occupants will not be relocated, and/or the just compensation will not be paid or deposited with the court for some parcels until after bid letting. KYTC will fully meet all the requirements outlined in 23 CFR 635.309(c)(3) and 49 CFR 24.102(j) and will expedite completion of all acquisitions, relocations, and full payments after bid letting and prior to AWARD of the construction contract or force account construction.			
Total Number of Parcels on Project	0	EXCEPTION (S) Parcel #	ANTICIPATED DATE OF POSSESSION WITH EXPLANATION
Number of Parcels That Have Been Acquired			
Signed Deed	0		
Condemnation	0		
Signed ROE	0		
Notes/ Comments (Use Additional Sheet if necessary)			
LPA RW Project Manager		Right of Way Supervisor	
Printed Name	Chad Bourke, P.E.	Printed Name	Mark C. Askin, P.E.
Signature		Signature	
Date	7-14-18	Date	97976
Right of Way Director		FHWA	
Printed Name	Dean M. Loy	Printed Name	
Signature		Signature	
Date	Digitally signed by DM Loy Date: 2018.09.14 13:37:44 -04'00'	Date	

UTILITIES AND RAIL CERTIFICATION NOTE

**JEFFERSON COUNTY, FD04 056 3396 C00033N
PARK BOUNDARY ROAD/BRIDGE REHABILITATION
SYP 05-10020**

Utility coordination efforts conducted by the project sponsor have determined that no significant utility relocation work is required to complete the project. Any work pertaining to these utility facilities is defined in the bid package and is to be carried out as instructed by the Kentucky Transportation Cabinet. The contractor will be responsible for any coordination or adjustments that are discussed or quantified in the proposal.

THE FOLLOWING RAIL COMPANIES HAVE FACILITIES IN CONJUNCTION WITH THIS PROJECT AS NOTED

No Rail Involved Minimal Rail Involved (See Below) Rail Involved (See Below)

UNDERGROUND FACILITY DAMAGE PROTECTION – BEFORE YOU DIG

The contractor shall make every effort to protect underground facilities from damage as prescribed in the Underground Facility Damage Protection Act of 1994, Kentucky Revised Statute KRS 367.4901 to 367.4917. It is the contractor's responsibility to determine and take steps necessary to be in compliance with federal and state damage prevention directives. The contractor is instructed to contact KY 811 for the location of existing underground utilities. Contact shall be made a minimum of two (2) and no more than ten (10) business days prior to excavation.

The contractor shall submit Excavation Locate Requests to the Kentucky Contact Center (KY 811) via web ticket entry. The submission of this request does not relieve the contractor from the responsibility of contacting non-member facility owners, whom are to be contacted through their individual Protection Notification Center. It may be necessary for the contractor to contact the County Court Clerk to determine what utility companies have facilities in the area. Non-compliance with these directives can result in the enforcement of penalties.

SPECIAL CAUTION NOTE – PROTECTION OF UTILITIES

The contractor will be responsible for contacting all utility facility owners on the subject project to coordinate his activities. The contractor will coordinate his activities to minimize and, where possible, avoid conflicts with utility facilities. Due to the nature of the work proposed, it is unlikely to conflict with the existing utilities beyond minor facility adjustments. Where conflicts with utility facilities are unavoidable, the contractor will coordinate any necessary relocation work with the facility owner and Resident Engineer. The

Kentucky Transportation Cabinet maintains the right to remove or alter portions of this contract if a utility conflict occurs.

UTILITIES AND RAIL CERTIFICATION NOTE

**JEFFERSON COUNTY, FD04 056 3396 C00033N
PARK BOUNDARY ROAD/BRIDGE REHABILITATION
SYP 05-10020**

The utility facilities as noted in the previous section(s) have been determined using data garnered by varied means and with varying degrees of accuracy: from the facility owners, a result of S.U.E., field inspections, and/or reviews of record drawings. The facilities defined may not be inclusive of all utilities in the project scope and are not Level A quality, unless specified as such. It is the contractor's responsibility to verify all utilities and their respective locations before excavating.

Please Note: The information presented in this Utility Note is informational in nature and the information contained herein is not guaranteed.

AREA UTILITIES CONTACT LIST AS PROVIDED BY KY 811

<u>Utility Company/Agency</u>	<u>Contact Name</u>	<u>Contact Information</u>
AT&T	Scott Roche	(502) 348-4528
LG&E	Mike Kress	(502) 364-8367
Louisville Water Company	Daniel Tegene	(502) 569-3649
MSD	Brandon Flaherty	(502) 540-6632

Kentucky Transportation
Cabinet Project: 5-10020

N O T I C E

**DEPARTMENT OF THE ARMY
CORPS OF ENGINEERS
NATIONWIDE SECTION 404 PERMIT AUTHORIZATION**

**DEPARTMENT FOR ENVIRONMENTAL PROTECTION
KENTUCKY DIVISION OF WATER
SECTION 401 WATER QUALITY CERTIFICATION**

PROJECT DESCRIPTION: **Bridge Rehabilitation of Park Boundary over Middle
Fork Beargrass Creek
Jefferson County, Kentucky
KYTC Item No. 5-10020**

The Sections 404 and 401 activities for this project have previously been permitted under the authority of the Department of the Army, Nationwide Section 404 Permit Number 14, *Linear Transportation Projects* (with additional *Kentucky Regional General Conditions*), and the Division of Section 401 Water General Water Quality Certification. For these authorized permits to be valid, the attached conditions must be followed. The contractor shall post a copy of this Nationwide Number 14 permit and General Water Quality Certification in a conspicuous location at the project site, with unencumbered public access, for the duration of construction and comply with the general conditions required.

Kentucky Transportation
 Cabinet Project: 5-10020

Locations Impacting Water Quality

Station-Location	Description
Bridge ID: 056C00033N	The project will involve the removal and replacement of existing asphalt and fill over the bridge arch, new waterproofing of the arch, clean and patch existing railings, patch existing masonry arch, reinforce bridge corners with turf reinforcement matting, and add new weep holes to existing drains. The project may require coffer dams in the stream. Project will not result in the loss of greater than 0.1 acre of waters of the U.S.; will not result in loss of greater than 300 feet of ephemeral, intermittent, or perennial stream; and will not discharge to a special aquatic site.

This project involves work near and/or within Jurisdictional Waters of the United States as defined by the U. S. Army Corps of Engineers; therefore, requiring a Nationwide Number 14 General Section 404 permit. The Division of Water conditionally certified this General Permit. Importantly, one of those conditions regards the use of heavy equipment in any stream channel, or streambed. If there is need to cross the stream channel with heavy equipment, or conduct work within the stream channel, a work platform or temporary crossing, is authorized. This should be constructed with clean rock (preferably sandstone or granite east of a line stretching from the McCreary-Wayne County line to the southwest, northeasterly to Lewis-Greenup County line), and sufficient pipe to allow stream flow to continue, unimpeded (refer to the attached standard drawing for low-water crossings at end of the document). Other conditions may be found under the heading, *General Certification—Nationwide Permit # 14 Linear Transportation Projects*.

In order for this authorization to be valid, the attached conditions must be followed. The contractor shall post a copy of this Nationwide Number 14 Approval in a conspicuous location at the project site, for the duration of the construction, and comply with the general conditions as required.

To more readily expedite construction, the contractor may elect to alter the design, or perform the work in a manner different from what was originally proposed and specified. Prior to commencing such alternative work, the contractor shall obtain written permission from the Division of Construction and the Kentucky Transportation Cabinet, Division of Environmental Analysis. If such changes necessitate further permitting, then the contractor will be responsible for applying to the U. S. Army Corps of Engineers and the Kentucky Division of Water. A copy of any request to the Corps of Engineers or Division of Water to alter this proposal and subsequent responses shall be forwarded to the Division of Environmental Analysis, DA Permit Coordinator, for office records and for informational purposes.



MATTHEW G. BEVIN
GOVERNOR

CHARLES G. SNAVELY
SECRETARY

**ENERGY AND ENVIRONMENT CABINET
DEPARTMENT FOR ENVIRONMENTAL PROTECTION**

R. BRUCE SCOTT
COMMISSIONER

300 SOWER BOULEVARD
FRANKFORT, KENTUCKY 40601

General Certification--Nationwide Permit # 14 Linear Transportation Projects

This General Certification is issued March 19, 2017, in conformity with the requirements of Section 401 of the Clean Water Act of 1977, as amended (33 U.S.C. §1341), as well as Kentucky Statute KRS 224.16-050.

For this and all nationwide permits, the definition of surface water is as per 401 KAR 10:001 Chapter 10, Section 1(80): Surface Waters means those waters having well-defined banks and beds, either constantly or intermittently flowing; lakes and impounded waters; marshes and wetlands; and any subterranean waters flowing in well-defined channels and having a demonstrable hydrologic connection with the surface. Lagoons used for waste treatment and effluent ditches that are situated on property owned, leased, or under valid easement by a permitted discharger are not considered to be surface waters of the commonwealth.

Agricultural operations, as defined by KRS 224.71-100(1) conducting activities pursuant to KRS 224.71-100 (3), (4), (5), (6), or 10 are deemed to have certification if they are implementing an Agriculture Water Quality Plan pursuant to KRS 224.71-145.

For all other operations, the Commonwealth of Kentucky hereby certifies under Section 401 of the Clean Water Act (CWA) that it has reasonable assurances that applicable water quality standards under Kentucky Administrative Regulations Title 401, Chapter 10, established pursuant to Sections 301, 302, 304, 306 and 307 of the CWA, will not be violated for the activity covered under NATIONWIDE PERMIT 14, namely Linear Transportation Projects, provided that the following conditions are met:

1. The activity will not occur within surface waters of the Commonwealth identified by the Kentucky Division of Water as Outstanding State or National Resource Water, Cold Water Aquatic Habitat, or Exceptional Waters.
2. The activity will not occur within surface waters of the Commonwealth identified as perpetually-protected (e.g. deed restriction, conservation easement) mitigation sites.
3. The activity will impact less than 1/2 acre of wetland/marsh.

General Certification--Nationwide Permit # 14
Linear Transportation Projects
Page 2

4. The activity will impact less than 300 linear feet of surface waters of the Commonwealth. Stream realignment greater than 100 feet and in-stream stormwater detention/retention basins are not covered under this general water quality certification.
5. For complete linear transportation projects, all impacts shall not exceed a cumulative length of 500 linear feet within each Hydrologic Unit Code (HUC) 14.
6. Any crossings must be constructed in a manner that does not impede natural water flow.
7. Stream impacts covered under this General Water Quality Certification and undertaken by those persons defined as an agricultural operation under the Agricultural Water Quality Act must be completed in compliance with the Kentucky Agricultural Water Quality Plan (KWQP).
8. The Kentucky Division of Water may require submission of a formal application for an individual certification for any project if the project has been determined to likely have a significant adverse effect upon water quality or degrade the waters of the Commonwealth so that existing uses of the water body or downstream waters are precluded.
9. Activities that do not meet the conditions of this General Water Quality Certification require an Individual Section 401 Water Quality Certification.
10. Activities qualifying for coverage under this General Water Quality Certification are subject to the following conditions:
 - Projects requiring in-stream stormwater detention/retention basins shall require individual water quality certifications.
 - Erosion and sedimentation pollution control plans and Best Management Practices must be designed, installed, and maintained in effective operating condition at all times during construction activities so that violations of state water quality standards do not occur (401 KAR 10:031 Section 2 and KRS 224.70-100).
 - Sediment and erosion control measures, such as check-dams constructed of any material, silt fencing, hay bales, etc., shall not be placed within surface waters of the Commonwealth, either temporarily or permanently, without prior approval by the Kentucky Division of Water's Water Quality Certification Section. If placement of sediment and erosion control measures in surface waters is unavoidable, design and placement of temporary erosion control measures shall not be conducted in such a manner that may result in instability of streams that are adjacent to,

General Certification--Nationwide Permit # 14
Linear Transportation Projects
Page 3

upstream, or downstream of the structures. All sediment and erosion control devices shall be removed and the natural grade restored within the completion timeline of the activities.

- Measures shall be taken to prevent or control spills of fuels, lubricants, or other toxic materials used in construction from entering the watercourse.
- Removal of riparian vegetation in the utility line right-of-way shall be limited to that necessary for equipment access.
- To the maximum extent practicable, all in-stream work under this certification shall be performed under low-flow conditions.
- Heavy equipment, e.g. bulldozers, backhoes, draglines, etc., if required for this project, should not be used or operated within the stream channel. In those instances in which such in-stream work is unavoidable, then it shall be performed in such a manner and duration as to minimize turbidity and disturbance to substrates and bank or riparian vegetation.
- Any fill shall be of such composition that it will not adversely affect the biological, chemical, or physical properties of the receiving waters and/or cause violations of water quality standards. If rip-rap is utilized, it should be of such weight and size that bank stress or slump conditions will not be created because of its placement.
- If there are water supply intakes located downstream that may be affected by increased turbidity and suspended solids, the permittee shall notify the operator when such work will be done.
- Should evidence of stream pollution or jurisdictional wetland impairment and/or violations of water quality standards occur as a result of this activity (either from a spill or other forms of water pollution), the KDOW shall be notified immediately by calling (800) 928-2380.

Non-compliance with the conditions of this general certification or violation of Kentucky state water quality standards may result in civil penalties.



**US Army Corps
of Engineers®**
Louisville District

2017 Nationwide Permit General Conditions

The following General Conditions must be followed in order for any authorization by NWP to be valid:

1. Navigation. (a) No activity may cause more than a minimal adverse effect on navigation.
 - (b) Any safety lights and signals prescribed by the US Coast Guard, through regulations or otherwise, must be installed and maintained at the permittee's expense on authorized facilities in navigable waters of the United States.
 - (c) The permittee understands and agrees that, if future operations by the United States require the removal, relocation, or other alteration, of the structure or work herein authorized, or if, in the opinion of the Secretary of the Army or his authorized representative, said structure or work shall cause unreasonable obstruction to the free navigation of the navigable waters, the permittee will be required, upon due notice from the Corps of Engineers, to remove, relocate, or alter the structural work or obstructions caused thereby, without expense to the United States. No claim shall be made against the United States on account of any such removal or alteration.
2. Aquatic Life Movements. No activity may substantially disrupt the necessary life cycle movements of those species of aquatic life indigenous to the waterbody, including those species that normally migrate through the area, unless the activity's primary purpose is to impound water. All permanent and temporary crossings of waterbodies shall be suitably culverted, bridged, or otherwise designed and constructed to maintain low flows to sustain the movement of those aquatic species.
 3. Spawning Areas. Activities in spawning areas during spawning seasons must be avoided to the maximum extent practicable. Activities that result in the physical destruction (e.g., through excavation, fill, or downstream smothering by substantial turbidity) of an important spawning area are not authorized.
 4. Migratory Bird Breeding Areas. Activities in waters of the United States that serve as breeding areas for migratory birds must be avoided to the maximum extent practicable.
 5. Shellfish Beds. No activity may occur in areas of concentrated shellfish populations, unless the activity is directly related to a shellfish harvesting activity authorized by NWPs 4 and 48, or is a shellfish seeding or habitat restoration activity authorized by NWP 27.
 6. Suitable Material. No activity may use unsuitable material (e.g., trash, debris, car bodies, asphalt, etc.). Material used for construction or discharged must be free from toxic pollutants in toxic amounts (see Section 307 of the Clean Water Act).
 7. Water Supply Intakes. No activity may occur in the proximity of a public water supply intake, except where the activity is for the repair or improvement of public water supply intake structures or adjacent bank stabilization.
 8. Adverse Effects From Impoundments. If the activity creates an impoundment of water, adverse effects to the aquatic system due to accelerating the passage of water, and/or restricting its flow must be minimized to the maximum extent practicable.
 9. Management of Water Flows. To the maximum extent practicable, the pre-construction course, condition, capacity, and location of open waters must be maintained for each activity, including stream channelization, storm water management activities, and temporary and permanent road crossings, except as provided below. The activity must be constructed to withstand expected high flows. The activity must not restrict or impede the passage of normal or high flows, unless the primary purpose of the activity is to impound water or manage high flows. The activity may alter the pre-construction course, condition, capacity, and location of open waters if it benefits the aquatic environment (e.g., stream restoration or relocation activities).
 10. Fills Within 100-Year Floodplains. The activity must comply with applicable FEMA-approved state or local floodplain management requirements.
 11. Equipment. Heavy equipment working in wetlands or mudflats must be placed on mats, or other measures must be taken to minimize soil disturbance.

12. Soil Erosion and Sediment Controls. Appropriate soil erosion and sediment controls must be used and maintained in effective operating condition during construction, and all exposed soil and other fills, as well as any work below the ordinary high water mark or high tide line, must be permanently stabilized at the earliest practicable date. Permittees are encouraged to perform work within waters of the United States during periods of low-flow or no-flow, or during low tides.
 13. Removal of Temporary Fills. Temporary fills must be removed in their entirety and the affected areas returned to pre-construction elevations. The affected areas must be revegetated, as appropriate.
 14. Proper Maintenance. Any authorized structure or fill shall be properly maintained, including maintenance to ensure public safety and compliance with applicable NWP general conditions, as well as any activity-specific conditions added by the district engineer to an NWP authorization.
15. Single and Complete Project. The activity must be a single and complete project. The same NWP cannot be used more than once for the same single and complete project.

16. Wild and Scenic Rivers. (a) No activity may occur in a component of the National Wild and Scenic River System, or in a river officially designated by Congress as a "study river" for possible inclusion in the system while the river is in an official study status, unless the appropriate Federal agency with direct management responsibility for such river, has determined in writing that the proposed activity will not adversely affect the Wild and Scenic River designation or study status.
 - (b) If a proposed NWP activity will occur in a component of the National Wild and Scenic River System, or in a river officially designated by Congress as a "study river" for possible inclusion in the system while the river is in an official study status, the permittee must submit a pre-construction notification (see general condition 32). The district engineer will coordinate the PCN with the Federal agency with direct management responsibility for that river. The permittee shall not begin the NWP activity until notified by the district engineer that the Federal agency with direct management responsibility for that river has determined in writing that the proposed NWP activity will not adversely affect the Wild and Scenic River designation or study status.

- (c) Information on Wild and Scenic Rivers may be obtained from the appropriate Federal land management agency responsible for the designated Wild and Scenic River or study river (e.g., National Park Service, U.S. Forest Service, Bureau of Land Management, U.S. Fish and Wildlife Service). Information on these rivers is also available at: <http://www.rivers.gov/>

17. Tribal Rights. No activity may impair tribal rights (including treaty rights), protected tribal resources, or tribal lands.

18. Endangered Species. (a) No activity is authorized under any NWP which is likely to directly or indirectly jeopardize the continued existence of a threatened or endangered species or a species proposed for such designation, as identified under the Federal Endangered Species Act (ESA), or which will directly or indirectly destroy or adversely modify the critical habitat of such species. No activity is authorized under any NWP which "may affect" a listed species or critical habitat, unless section 7 consultation addressing the effects of the proposed activity has been completed. Direct effects are the immediate effects on the listed species and critical habitat caused by the NWP activity. Indirect effects are those effects on listed species and critical habitat that are caused by the NWP activity and are later in time, but still are reasonably certain to occur.
 - (b) Federal agencies should follow their own procedures for complying with the requirements of the ESA. If pre-construction notification is required for the proposed activity, the Federal permittee must provide the district engineer with the appropriate documentation to demonstrate compliance with those requirements. The district engineer will verify that the appropriate documentation has been submitted. If the appropriate documentation has not been submitted, additional ESA section 7 consultation may be necessary for the activity and the respective federal agency would be responsible for fulfilling its obligation under section 7 of the ESA.

(c) Non-federal permittees must submit a pre-construction notification (PCN) to the district engineer if any listed species or designated critical habitat might be affected or is in the vicinity of the activity, or if the activity is located in designated critical habitat, and shall not begin work on the activity until notified by the district engineer that the requirements of the ESA have been satisfied and that the activity is authorized. For activities that might affect Federally-listed endangered or threatened species or designated critical habitat, the PCN must include the name(s) of the endangered or threatened species that might be affected by the proposed activity or that utilize the designated critical habitat that might be affected by the proposed work. The district engineer will determine whether the proposed activity "may affect" or will have "no effect" to listed species and designated critical habitat and will notify the non-Federal applicant of the Corps' determination within 45 days of receipt of a complete PCN. In cases where the non-Federal applicant has identified listed species or critical habitat that might be affected or is in the vicinity of the activity, and has so notified the Corps, the applicant shall not begin work until the Corps has provided notification the proposed activities will have "no effect" on listed species or critical habitat, or until Section 7 consultation has been completed. If the non-Federal applicant has not heard back from the Corps within 45 days, the applicant must still wait for notification from Corps.

(d) As a result of formal or informal consultation with the USFWS or NMFS the district engineer may add species-specific permit conditions to the NWP's.

(e) Authorization of an activity by a NWP does not authorize the "take" of a threatened or endangered species as defined under the ESA. In the absence of separate authorization (e.g., an ESA Section 10 Permit, a Biological Opinion with "incidental take" provisions, etc.) from the USFWS or the NMFS, the Endangered Species Act prohibits any person subject to the jurisdiction of the United States to take a listed species, where "take" means to harass, harm, pursue, hunt, shoot, wound, kill, trap, capture, or collect, or to attempt to engage in any such conduct. The word "harm" in the definition of "take" means an act which actually kills or injures wildlife. Such an act may include significant habitat modification or degradation where it actually kills or injures wildlife by significantly impairing essential behavioral patterns, including breeding, feeding or sheltering.

(f) If the non-federal permittee has a valid ESA section 10(a)(1)(B) incidental take permit with an approved Habitat Conservation Plan for a project or a group of projects that includes the proposed NWP activity, the non-federal applicant should provide a copy of that ESA section 10(a)(1)(B) permit with the PCN required by paragraph (c) of this general condition. The district engineer will review the ESA section 10(a)(1)(B) permit, and if he or she determines that it covers the proposed NWP activity, including any incidental take of listed species that might occur as a result of conducting the proposed NWP activity, the district engineer does not need to conduct a separate section 7 consultation for the proposed NWP activity. The district engineer will notify the non-federal applicant within 45 days of receipt of a complete PCN whether the ESA section 10(a)(1)(B) permit covers the proposed NWP activity or whether additional ESA section 7 consultation is required.

(g) Information on the location of threatened and endangered species and their critical habitat can be obtained directly from the offices of the USFWS and NMFS or their world wide web pages at <http://www.fws.gov/> or <http://www.fws.gov/ipac> and <http://www.nmfs.noaa.gov/dsp/species/esa> respectively.

19. **Migratory Birds and Bald and Golden Eagles.** The permittee is responsible for ensuring their action complies with the Migratory Bird Treaty Act and the Bald and Golden Eagle Protection Act. The permittee is responsible for contacting appropriate local office of the U.S. Fish and Wildlife Service to determine applicable measures to reduce impacts to migratory birds or eagles, including whether "incidental take" permits are necessary and available under the Migratory Bird Treaty Act or Bald and Golden Eagle Protection Act for a particular activity.

20. **Historic Properties.** (a) In cases where the district engineer determines that the activity may have the potential to cause effects to properties listed, or eligible for listing, in the National Register of Historic Places, the activity is not authorized, until the requirements of Section 106 of the National Historic Preservation Act (NHPA) have been satisfied.

(b) Federal permittees should follow their own procedures for complying with the requirements of Section 106 of the National Historic Preservation Act. If pre-construction notification is required for the proposed NWP activity, the Federal permittee must provide the district engineer with the appropriate documentation to demonstrate compliance with those

requirements. The district engineer will verify that the appropriate documentation has been submitted. If the appropriate documentation is not submitted, then additional consultation under section 106 may be necessary. The respective federal agency is responsible for fulfilling its obligation to comply with section 106.

(c) Non-federal permittees must submit a pre-construction notification to the district engineer if the NWP activity might have the potential to cause effects to any historic properties listed on, determined to be eligible for listing on, or potentially eligible for listing on the National Register of Historic Places, including previously unidentified properties. For such activities, the pre-construction notification must state which historic properties might have the potential to be affected by the proposed activity or include a vicinity map indicating the location of the historic properties or the potential for the presence of historic properties. Assistance regarding information on the location of or potential for the presence of historic properties can be sought from the State Historic Preservation Officer, Tribal Historic Preservation Officer, or designated tribal representative, as appropriate, and the National Register of Historic Places (see 33 CFR 330.4(g)). When reviewing pre-construction notifications, district engineers will comply with the current procedures for addressing the requirements of Section 106 of the National Historic Preservation Act. The district engineer shall make a reasonable and good faith effort to carry out appropriate identification efforts, which may include background research, consultation, oral history interviews, sample field investigation, and field survey. Based on the information submitted in the PCN and these identification efforts, the district engineer shall determine whether the proposed NWP activity has the potential to cause an effect on the historic properties. Section 106 consultation is not required when the district engineer determines that the activity does not have the potential to cause effects on historic properties (see 36 CFR 800.3(a)). Section 106 consultation is required when the district engineer determines that the activity has the potential to cause effects on historic properties. The district engineer will conduct consultation with consulting parties identified under 36 CFR 800.2(c) when he or she makes any of the following effect determinations for the purposes of section 106 of the NHPA: no historic properties affected, no adverse effect, and adverse effect. Where the non-Federal applicant has identified historic properties on which the activity might have the potential to cause effects and notified the Corps, the non-Federal applicant shall not begin the activity until notified by the district engineer either that the activity has no potential to cause effects to historic properties or that NHPA section 106 consultation has been completed.

(d) For non-federal permittees, the district engineer will notify the prospective permittee within 45 days of receipt of a complete pre-construction notification whether NHPA section 106 consultation is required. If NHPA section 106 consultation is required, the district engineer will notify the non-federal applicant that he or she cannot begin the activity until Section 106 consultation is completed. If the non-Federal applicant has not heard back from the Corps within 45 days, the applicant must still wait for notification from the Corps.

(e) Prospective permittees should be aware that section 110k of the NHPA (54 U.S.C. 306113) prevents the Corps from granting a permit or other assistance to an applicant who, with intent to avoid the requirements of Section 106 of the NHPA, has intentionally significantly adversely affected a historic property to which the permit would relate, or having legal power to prevent it, allowed such significant adverse effect to occur, unless the Corps, after consultation with the Advisory Council on Historic Preservation (ACHP), determines that circumstances justify granting such assistance despite the adverse effect created or permitted by the applicant. If circumstances justify granting the assistance, the Corps is required to notify the ACHP and provide documentation specifying the circumstances, the degree of damage to the integrity of any historic properties affected, and proposed mitigation. This documentation must include any views obtained from the applicant, SHPO/THPO, appropriate Indian tribes if the undertaking occurs on or affects historic properties on tribal lands or affects properties of interest to those tribes, and other parties known to have a legitimate interest in the impacts to the activity on historic properties.

21. **Discovery of Previously Unknown Remains and Artifacts.** If you discover any previously unknown historic, cultural or archaeological remains and artifacts while accomplishing the activity authorized by this permit, you must immediately notify the district engineer of what you have found, and to the maximum extent practicable, avoid construction activities that may affect the remains and artifacts until the required coordination has been completed. The district engineer will initiate the Federal, Tribal and state coordination required to determine if the items or remains warrant recovery effort or if the site is eligible for listing in the National Register of Historic Places.

22. Designated Critical Resource Waters. Critical resource waters include, NOAA-managed marine sanctuaries and marine monuments, and National Estuarine Research Reserves. The district engineer may designate, after notice and opportunity for public comment, additional waters officially designated by a state as having particular environmental or ecological significance, such as outstanding national resource waters or state natural heritage sites. The district engineer may also designate additional critical resource waters after notice and opportunity for public comment.

(a) Discharges of dredged or fill material into waters of the US are not authorized by NWP's 7, 12, 14, 16, 17, 21, 29, 31, 35, 39, 40, 42, 43, 44, 49, 50, 51, and 52 for any activity within, or directly affecting, critical resource waters, including wetlands adjacent to such waters.

(b) For NWP's 3, 8, 10, 13, 15, 18, 19, 22, 23, 25, 27, 28, 30, 33, 34, 36, 37, 38, and 54, notification is required in accordance with general condition 32, for any activity proposed in the designated critical resource waters including wetlands adjacent to those waters. The district engineer may authorize activities under these NWP's only after it is determined that the impacts to the critical resource waters will be no more than minimal.

23. Mitigation. The district engineer will consider the following factors when determining appropriate and practicable mitigation necessary to ensure that the individual and cumulative adverse environmental effects are no more than minimal:

(a) The activity must be designed and constructed to avoid and minimize adverse effects, both temporary and permanent, to waters of the United States to the maximum extent practicable at the project site (i.e., on site).

(b) Mitigation in all its forms (avoiding, minimizing, rectifying, reducing, or compensating for resource losses) will be required to the extent necessary to ensure that the individual and cumulative adverse environmental effects are no more than minimal.

(c) Compensatory mitigation at a minimum one-for-one ratio will be required for all wetland losses that exceed 1/10-acre and require pre-construction notification, unless the district engineer determines in writing that either some other form of mitigation would be more environmentally appropriate or the adverse effects of the proposed activity are minimal, and provides a project-specific waiver of this requirement. For wetland losses of 1/10-acre or less that require pre-construction notification, the district engineer may determine on a case-by-case basis that compensatory mitigation is required to ensure that the activity results in minimal adverse environmental effects.

(d) For losses of streams or other open waters that require pre-construction notification, the district engineer may require compensatory mitigation to ensure that the activity results in no more than minimal adverse environmental effects. Compensatory mitigation for losses of streams should be provided, if practicable, through stream rehabilitation, enhancement, or preservation, since streams are difficult-to-replace resources (see 33 CFR 332.3(e)(3)).

(e) Compensatory mitigation plans for NWP activities in or near streams or other open waters will normally include a requirement for the restoration or enhancement, maintenance, and legal protection (e.g. conservation easements) of riparian areas next to open waters. In some cases, the restoration or maintenance/protection of riparian areas may be the only compensatory mitigation required. Restored riparian areas should consist of native species. The width of the required riparian area will address documented water quality or aquatic habitat loss concerns. Normally, the riparian area will be 25 to 50 feet wide on each side of the stream, but the district engineer may require slightly wider riparian areas to address documented water quality or habitat loss concerns. If it is not possible to restore or maintain/protect a riparian area on both sides of a stream or if the waterbody is a lake or coastal waters. Then restoring or maintaining/protecting a riparian area along a single bank or shoreline may be sufficient. Where both wetlands and open waters exist on the project site, the district engineer will determine the appropriate compensatory mitigation (e.g. riparian areas and/or wetlands compensation) based on what is best for the aquatic environmental on a watershed basis. In cases where riparian areas are determined to be the most appropriate form of minimization or compensatory mitigation, the district engineer may waive or reduce the requirement to provide wetland compensatory mitigation for wetland losses.

(f) Compensatory mitigation projects provided to offset losses of aquatic resources must comply with the applicable provisions of 33 CFR part 332.

(1) The prospective permittee is responsible for proposing an appropriate compensatory mitigation option if compensatory mitigation is necessary to ensure that the activity results in no more than minimal adverse environmental effects. For the NWP's, the preferred mechanism for providing compensatory mitigation is mitigation bank credits or in-lieu fee program credits (see 33 CFR 332.3(b)(2) and (3)). However, if an appropriate number and type of mitigation bank or in-lieu credits are not available at the time the PCN is submitted to the district engineer, the district engineer may approve the use of permittee-responsible mitigation if the use of mitigation bank or in-lieu fee program credits is not appropriate and practicable.

(2) The amount of compensatory mitigation required by the district engineer must be sufficient to ensure that the authorized activity results in no more than minimal individual and cumulative adverse environmental effects (see 33 CFR 330.1(e)(3)). (See also 33 CFR 332.3(f).)

(3) Since the likelihood of success is greater, and the impacts to potentially valuable uplands are reduced, aquatic resource restoration should be the first compensatory mitigation option considered for permittee-responsible mitigation.

(4) If permittee-responsible mitigation is the proposed option, the prospective permittee is responsible for submitting a mitigation plan. A conceptual or detailed mitigation plan may be used by the district engineer to make the decision on the NWP verification request, but a final mitigation plan that addresses the applicable requirements of 33 CFR 332.4(c)(2) through (14) must be approved by the district engineer before the permittee begins work in waters of the United States, unless the district engineer determines that prior approval of the final mitigation plan is not practicable or not necessary to ensure timely completion of the required compensatory mitigation (see 33 CFR 332.3(k)(3)).

(5) If mitigation bank or in-lieu fee program credits are the proposed option, the mitigation plan only needs to address the baseline conditions at the impact site and the number of credits to be provided.

(6) Compensatory mitigation requirements (e.g., resource type and amount) to be provided as compensatory mitigation, site protection, ecological performance standards, monitoring requirements) may be addressed through conditions added to the NWP authorization, instead of components of a compensatory mitigation plan.

(g) Compensatory mitigation will not be used to increase the acreage losses allowed by the acreage limits of the NWP's. For example, if an NWP has an acreage limit of 1/2-acre, it cannot be used to authorize any project resulting in the loss of greater than 1/2-acre of waters of the United States, even if compensatory mitigation is provided that replaces or restores some of the lost waters. However, compensatory mitigation can and should be used, as necessary, to ensure that an NWP activity already meeting the established acreage limits also satisfies the minimal impact requirement for the NWP's.

(h) Permittees may propose the use of mitigation banks, in-lieu fee programs, or separate permittee-responsible mitigation. When developing a compensatory mitigation proposal, the permittee must consider appropriate and practicable options consistent with the framework at 33 CFR 332.3(b). For activities resulting in the loss of marine or estuarine resources, permittee-responsible compensatory mitigation may be environmentally preferable if there are no mitigation banks or in-lieu fee programs in the area that have marine or estuarine credits available for sale or transfer to the permittee. For permittee-responsible mitigation, the special conditions of the NWP verification must clearly indicate the party or parties responsible for the implementation and performance of the compensatory mitigation project, and, if required, its long-term management.

(i) Where certain functions and services of waters of the United States are permanently adversely affected by a regulated activity, such as discharges of dredged or fill material into waters of the United States that will convert a forested or scrub-shrub wetland to a herbaceous wetland in a permanently maintained utility line right-of-way, mitigation may be required to reduce the adverse environmental effects of the activity to the no more than minimal level.

24. Safety of Impoundment Structures. To ensure that all impoundment structures are safely designed, the district engineer may require non-Federal applicants to demonstrate that the structures comply with established state dam safety criteria or have been designed by qualified persons. The district engineer may also require documentation that the design has been independently reviewed by similarly qualified persons, and appropriate modifications made to ensure safety.

25. Water Quality. Where States and authorized Tribes, or EPA where applicable, have not previously certified compliance of an NWP with CWA Section 401, individual 401 Water Quality

Certification must be obtained or waived (see 33 CFR 330.4(c)). The district engineer or State or Tribe may require additional water quality management measures to ensure that the authorized activity does not result in more than minimal degradation of water quality.

26. Coastal Zone Management. In coastal states where an NWP has not previously received a state coastal zone management consistency concurrence, an individual state coastal zone management consistency concurrence must be obtained, or a presumption of concurrence must occur (see 33 CFR 330.4(d)). The district engineer or a State may require additional measures to ensure that the authorized activity is consistent with state coastal zone management requirements.

27. Regional and Case-By-Case Conditions. The activity must comply with any regional conditions that may have been added by the Division Engineer (see 33 CFR 330.4(e)) and with any case specific conditions added by the Corps or by the state, Indian Tribe, or USEPA in its section 401 Water Quality Certification, or by the state in its Coastal Zone Management Act consistency determination.

28. Use of Multiple Nationwide Permits. The use of more than one NWP for a single and complete project is prohibited, except when the acreage loss of waters of the United States authorized by the NWPs does not exceed the acreage limit of the NWP with the highest specified acreage limit. For example, if a road crossing over tidal waters is constructed under NWP 14, with associated bank stabilization authorized by NWP 13, the maximum acreage loss of waters of the United States for the total project cannot exceed 1/3-acre.

29. Transfer of Nationwide Permit Verifications. If the permittee sells the property associated with a nationwide permit verification, the permittee may transfer the nationwide permit verification to the new owner by submitting a letter to the appropriate Corps district office to validate the transfer. A copy of the nationwide permit verification must be attached to the letter, and the letter must contain the following statement and signature: "When the structures or work authorized by this nationwide permit are still in existence at the time the property is transferred, the terms and conditions of this nationwide permit, including any special conditions, will continue to be binding on the new owner(s) of the property. To validate the transfer of this nationwide permit and the associated liabilities associated with compliance with its terms and conditions, have the transferee sign and date below."

(Transferee)

(Date)

30. Compliance Certification. Each permittee who receives an NWP verification letter from the Corps must provide a signed certification documenting completion of the authorized activity and implementation of any required compensatory mitigation. The success of any required permittee-responsible mitigation, including the achievement of ecological performance standards, will be addressed separately by the district engineer. The Corps will provide the permittee the certification document with the NWP verification letter. The certification document will include:

(a) A statement that the authorized work was done in accordance with the NWP authorization, including any general, regional, or activity-specific conditions;

(b) A statement that the implementation of any required compensatory mitigation was completed in accordance with the permit conditions. If credits from a mitigation bank or in-lieu fee program are used to satisfy the compensatory mitigation requirements, the certification must include the documentation required by 33 CFR 332.3(i)(3) to confirm that the permittee secured the appropriate number and resource type of credits; and

(c) The signature of the permittee certifying the completion of the work and mitigation. The completed certification document must be submitted to the district engineer within 30 days of completion of the authorized activity or the implementation of any required compensatory mitigation, whichever occurs later.

31. Activities Affecting Structures or Works Built by the United States. If an NWP activity also requires permission from the Corps pursuant to 33 U.S.C. 408 because it will alter or temporarily or permanently occupy or use a U.S. Army Corps of Engineers (USACE) federally

authorized Civil Works project (a "USACE project"), the prospective permittee must submit a pre-construction notification. See paragraph (b)(10) of general condition 32. An activity that requires Section 408 permission is not authorized by the NWP until the appropriate Corps office issues the section 408 permission to alter, occupy, or use the USACE project, and the district engineer issues a written NWP verification.

32. Pre-Construction Notification (PCN). (a) Timing. Where required by the terms of the NWP, the prospective permittee must notify the district engineer by submitting a pre-construction notification (PCN) as early as possible. The district engineer must determine if the PCN is complete within 30 calendar days of the date of receipt and, if the PCN is determined to be incomplete, notify the prospective permittee within that 30 day period to request the additional information necessary to make the PCN complete. As a general rule, district engineers will request additional information necessary to make the PCN complete only once. However, if the prospective permittee does not provide all of the requested information, then the district engineer will notify the prospective permittee that the PCN is still incomplete and the PCN review process will not commence until all of the requested information has been received by the district engineer. The prospective permittee shall not begin the activity until either:

(1) He or she is notified in writing by the district engineer that the activity may proceed under the NWP with any special conditions imposed by the district or division engineer; or

(2) 45 calendar days have passed from the district engineer's receipt of the complete PCN and the prospective permittee has not received written notice from the district or division engineer. However, if the permittee was required to notify the Corps pursuant to general condition 18 that listed species or critical habitat might be affected or in the vicinity of the project, or to notify the Corps pursuant to general condition 20 that the activity might have the potential to cause effects to historic properties, the permittee cannot begin the activity until receiving written notification from the Corps that there is "no effect" on listed species or "no potential to cause effects" on historic properties, or that any consultation required under Section 7 of the Endangered Species Act (see 33 CFR 330.4(f) and/or Section 106 of the National Historic Preservation Act (see 33 CFR 330.4(g)) has been completed. Also, work cannot begin under NWPs 21, 49, or 50 until the permittee has received written approval from the Corps. If the proposed activity requires a written waiver to exceed specified limits of an NWP, the permittee may not begin the activity until the district engineer issues the waiver. If the district or division engineer notifies the permittee in writing that an individual permit is required within 45 calendar days of receipt of a complete PCN, the permittee cannot begin the activity until an individual permit has been obtained. Subsequently, the permittee's right to proceed under the NWP may be modified, suspended, or revoked only in accordance with the procedure set forth in 33 CFR 330.5(d)(2).

(b) Contents of Pre-Construction Notification: The PCN must be in writing and include the following information:

(1) Name, address and telephone numbers of the prospective permittee;

(2) Location of the proposed activity;

(3) Identify the specific NWP or NWPs (s) the prospective permittee wants to use to authorize the proposed activity;

(4) A description of the proposed activity; the activity's purpose; direct and indirect adverse environmental effects the activity would cause, including the anticipated amount of loss of wetlands, other special aquatic sites, and other waters expected to result from the NWP activity, in acres, linear feet, or other appropriate unit of measure; a description of any proposed mitigation measures intended to reduce the adverse environmental effects caused by the proposed activity; and any other NWP(s), regional general permit(s), or individual permit(s) used or intended to be used to authorize any part of the proposed project or any related activity, including other separate and distant crossings for linear projects that require Department of the Army authorization but do not require pre-construction notification. The description of the proposed activity and any proposed mitigation measures should be sufficiently detailed to allow the district engineer to determine that the adverse environmental effects of the activity will be no more than minimal and to determine the need for compensatory mitigation or other mitigation measures. For single and complete linear projects, the PCN must include the quantity of anticipated losses of wetlands, other special aquatic sites, and other water for each single and complete crossing of those wetlands, other special aquatic sites, and other waters. Sketches should be provided when necessary to show that the activity complies with the terms of the NWP. (Sketches usually clarify the project and when provided results in a quicker decision. Sketches should contain sufficient detail to provide an

illustrative description of the proposed activity (e.g., a conceptual plan), but do not need to be detailed engineering plans):

(5) The PCN must include a delineation of wetlands, other special aquatic sites, and other waters, such as lakes and ponds, and perennial, intermittent, and ephemeral streams, on the project site. Wetland delineations must be prepared in accordance with the current method required by the Corps. The permittee may ask the Corps to delineate the special aquatic sites and other waters on the project site, but there may be a delay if the Corps does the delineation, especially if the project site is large or contains many wetlands, other special aquatic sites, and other waters. Furthermore, the 45 day period will not start until the delineation has been submitted to or completed by the Corps, as appropriate.

(6) If the proposed activity will result in the loss of greater than 1/10-acre of wetlands and a PCN is required, the prospective permittee must submit a statement describing how the mitigation requirement will be satisfied, or explaining why the adverse environmental effects are no more than minimal and why compensatory mitigation should not be required. As an alternative, the prospective permittee may submit a conceptual or detailed mitigation plan.

(7) For non-federal permittees, if any listed species or designated critical habitat might be affected or is in the vicinity of the project, or if the project is located in designated critical habitat, for non-Federal applicants the PCN must include the name(s) of those endangered or threatened species that might be affected by the proposed activity or utilize the designated critical habitat that may be affected by the proposed activity. For any NWP activity that requires pre-construction notification, Federal permittees must provide documentation demonstrating compliance with the Endangered Species Act:

(8) For non-federal permittees, if the NWP activity might have the potential to cause effects to a historic property listed on, determined to be eligible for listing on, or potentially eligible for listing on, the National Register of Historic Places, the PCN must state which historic property might have the potential to be affected by the proposed activity or include a vicinity map indicating the location of the historic property. Federal permittees must provide documentation demonstrating compliance with Section 106 of the National Historic Preservation Act.

(9) For an activity that will occur in a component of the National Wild and Scenic River System, or in a river officially designated by Congress as a "study river" for possible inclusion in the system while the river is in an official study status, the PCN must identify the Wild and Scenic River or the "study river" (see general condition 16); and

(10) For an activity that requires permission from the Corps pursuant to 33 U.S.C. 408 because it will alter or temporarily or permanently occupy or use a U.S. Army Corps of Engineers federally authorized civil works project, the pre-construction notification must include a statement confirming that the project proponent has submitted a written request for section 408 permission from the Corps office having jurisdiction over that USACE project.

(c) Form of PCN Notification: The standard individual permit application form (Form ENG 4345) may be used, but the completed application form must clearly indicate that it is an NWP PCN and must include all of the information required in paragraphs (b)(1) through (10) of this general condition. A letter containing the required information may also be used. Applicants may provide electronic files of PCNs and supporting materials if the district engineer has established tools and procedures for electronic submissions.

(d) Agency Coordination: (1) The district engineer will consider any comments from Federal and state agencies concerning the proposed activity's compliance with the terms and conditions of the NWPs and the need for mitigation to reduce the project's adverse environmental effects so that they are no more than minimal.

(2) Agency coordination is required for: (i) all NWP activities that require preconstruction notification and result in the loss of greater than 1/2-acre of waters of the United States; (ii) NWP 21, 29, 39, 40, 42, 43, 44, 50, 51, and 52 activities that require pre-construction notification and will result in the loss of greater than 300 linear feet of stream bed; (iii) NWP 13 activities in excess of 500 linear feet, fills greater than one cubic yard per running foot, or involve discharges of dredged or fill material into special aquatic sites; and (iv) NWP 54 activities in excess of 500 linear feet, or that extend into the waterbody more than 30 feet from the mean low water line or ordinary high water mark.

(3) When agency coordination is required, the district engineer will immediately provide (e.g., via e-mail, facsimile transmission, overnight mail, or other expeditious manner) a copy of the complete PCN to the appropriate Federal or state offices (FWS, state natural

resource or water quality agency, EPA, and, if appropriate, the NMFS). With the exception of NWP 37, these agencies will have 10 calendar days from the date the material is transmitted to notify the district engineer via telephone, facsimile transmission, or e-mail that they intend to provide substantive, site specific comments. The comments must explain why the agency believes the adverse environmental effects will be more than minimal. If so contacted by an agency, the district engineer will wait an additional 15 calendar days before making a decision on the pre-construction notification. The district engineer will fully consider agency comments received within the specified time frame concerning the proposed activity's compliance with the terms and conditions of the NWPs, including the need for mitigation to ensure the net adverse environmental effects of the proposed activity are no more than minimal. The district engineer will provide no response to the proposed agency, except as provided below. The district engineer will indicate in the administrative record associated with each pre-construction notification that the resource agencies' concerns were considered. For NWP 37, the emergency watershed protection and rehabilitation activity may proceed immediately in cases where there is an unacceptable hazard to life or a significant loss of property or economic hardship will occur. The district engineer will consider any comments received to decide whether the NWP 37 authorization should be modified, suspended, or revoked in accordance with the procedures at 33 CFR 330.5.

(4) In cases of where the prospective permittee is not a Federal agency, the district engineer will provide a response to NMFS within 30 calendar days of receipt of any Essential Fish Habitat conservation recommendations, as required by Section 305(b)(4)(B) of the Magnuson-Stevens Fishery Conservation and Management Act.

(5) Applicants are encouraged to provide the Corps with either electronic files or multiple copies of PCN notifications to expedite agency coordination.

Further Information

1. District Engineers have authority to determine if an activity complies with the terms and conditions of an NWP.
2. NWPs do not obviate the need to obtain other federal, state, or local permits, approvals, or authorizations required by law.
3. NWPs do not grant any property rights or exclusive privileges.
4. NWPs do not authorize any injury to the property or rights of others.
5. NWPs do not authorize interference with any existing or proposed Federal project (see general condition 31).

Terms for Nationwide Permit No. 14 – Linear Transportation Projects

Activities required for crossings of waters of the United States associated with the construction, expansion, modification, or improvement of linear transportation projects (e.g., roads, highways, railways, trails, airport runways, and taxiways) in waters of the United States. For linear transportation projects in non-tidal waters, the discharge cannot cause the loss of greater than 1/2-acre of waters of the United States. For linear transportation projects in tidal waters, the discharge cannot cause the loss of greater than 1/3-acre of waters of the United States. Any stream channel modification, including bank stabilization, is limited to the minimum necessary to construct or protect the linear transportation project; such modifications must be in the immediate vicinity of the project.

This NWP also authorizes temporary structures, fills, and work, including the use of temporary mats, necessary to construct the linear transportation project. Appropriate measures must be taken to maintain normal downstream flows and minimize flooding to the maximum extent practicable, when temporary structures, work, and discharges, including cofferdams, are necessary for construction activities, access fills, or dewatering of construction sites. Temporary fills must consist of materials, and be placed in a manner, that will not be eroded by expected high flows. Temporary fills must be removed in their entirety and the affected areas returned to pre-construction elevations. The areas affected by temporary fills must be revegetated, as appropriate.

This NWP cannot be used to authorize non-linear features commonly associated with transportation projects, such as vehicle maintenance or storage buildings, parking lots, train stations, or aircraft hangars.

Notification: The permittee must submit a pre-construction notification to the district engineer prior to commencing the activity if: (1) the loss of waters of the United States exceeds 1/10-acre; or (2) there is a discharge in a special aquatic site, including wetlands. (See general condition 32.) (Authorities: Sections 10 and 404)

Note 1: For linear transportation projects crossing a single waterbody more than one time at separate and distant locations, or multiple waterbodies at separate and distant locations, each crossing is considered a single and complete project for purposes of NWP authorization. Linear transportation projects must comply with 33 CFR 330.6(d).

Note 2: Some discharges for the construction of farm roads or forest roads, or temporary roads for moving mining equipment, may qualify for an exemption under section 404(f) of the Clean Water Act (see 33 CFR 323.4).

Note 3: For NWP 14 activities that require pre-construction notification, the PCN must include any other NWP(s), regional general permit(s), or individual permit(s) used or intended to be used to authorize any part of the proposed project or any related activity, including other separate and distant crossings that require Department of the Army authorization but do not require pre-construction notification (see paragraph (b) of general condition 32). The district engineer will evaluate the PCN in accordance with Section D, "District Engineer's Decision." The district engineer may require mitigation to ensure that the authorized activity results in no more than minimal individual and cumulative adverse environmental effects (see general condition 23).

PART II
SPECIFICATIONS AND STANDARD DRAWINGS

SPECIFICATIONS REFERENCE

Any reference in the plans or proposal to previous editions of the *Standard Specifications for Road and Bridge Construction* and *Standard Drawings* are superseded by *Standard Specifications for Road and Bridge Construction, Edition of 2012* and *Standard Drawings, Edition of 2016*.

SUPPLEMENTAL SPECIFICATIONS

The contractor shall use the Supplemental Specifications that are effective at the time of letting.
The Supplemental Specifications can be found at the following link:

<http://transportation.ky.gov/Construction/Pages/Kentucky-Standard-Specifications.aspx>

PART III

EMPLOYMENT, WAGE AND RECORD REQUIREMENTS

**TRANSPORTATION CABINET
DEPARTMENT OF HIGHWAYS**

**LABOR AND WAGE REQUIREMENTS
APPLICABLE TO OTHER THAN FEDERAL-AID SYSTEM PROJECTS**

- I. Application
- II. Nondiscrimination of Employees (KRS 344)

I. APPLICATION

1. These contract provisions shall apply to all work performed on the contract by the contractor with his own organization and with the assistance of workmen under his immediate superintendence and to all work performed on the contract by piecework, station work or by subcontract. The contractor's organization shall be construed to include only workmen employed and paid directly by the contractor and equipment owned or rented by him, with or without operators.

2. The contractor shall insert in each of his subcontracts all of the stipulations contained in these Required Provisions and such other stipulations as may be required.

3. A breach of any of the stipulations contained in these Required Provisions may be grounds for termination of the contract.

3. If the contractor is in control of apprenticeship or other training or retraining, including on-the-job training programs, he shall not discriminate against an individual because of his race, color, religion, national origin, sex, disability or age forty (40) and over, in admission to, or employment in any program established to provide apprenticeship or other training.

4. The contractor will send to each labor union or representative of workers with which he has a collective bargaining agreement or other contract or understanding, a notice to be provided advising the said labor union or workers' representative of the contractor's commitments under this section, and shall post copies of the notice in conspicuous places available to employees and applicants for employment. The contractor will take such action with respect to any subcontract or purchase order as the administrating agency may direct as a means of enforcing such provisions, including sanctions for non-compliance.

Revised: January 25, 2017

II. NONDISCRIMINATION OF EMPLOYEES

**AN ACT OF THE KENTUCKY
GENERAL ASSEMBLY TO PREVENT
DISCRIMINATION IN EMPLOYMENT
KRS CHAPTER 344
EFFECTIVE JUNE 16, 1972**

The contract on this project, in accordance with KRS Chapter 344, provides that during the performance of this contract, the contractor agrees as follows:

1. The contractor shall not fail or refuse to hire, or shall not discharge any individual, or otherwise discriminate against an individual with respect to his compensation, terms, conditions, or privileges of employment, because of such individual's race, color, religion, national origin, sex, disability or age (forty and above); or limit, segregate, or classify his employees in any way which would deprive or tend to deprive an individual of employment opportunities or otherwise adversely affect his status as an employee, because of such individual's race, color, religion, national origin, sex, disability or age forty (40) and over. The contractor agrees to post in conspicuous places, available to employees and applicants for employment, notices to be provided setting forth the provisions of this nondiscrimination clause.

2. The contractor shall not print or publish or cause to be printed or published a notice or advertisement relating to employment by such an employer or membership in or any classification or referral for employment by the employment agency, indicating any preference, limitation, specification, or discrimination, based on race, color, religion, national origin, sex, or age forty (40) and over, or because the person is a qualified individual with a disability, except that such a notice or advertisement may indicate a preference, limitation, or specification based on religion, national origin, sex, or age forty (40) and over, or because the person is a qualified individual with a disability, when religion, national origin, sex, or age forty (40) and over, or because the person is a qualified individual with a disability, is a bona fide occupational qualification for employment.

EXECUTIVE BRANCH CODE OF ETHICS

In the 1992 regular legislative session, the General Assembly passed and Governor Brereton Jones signed Senate Bill 63 (codified as KRS 11A), the Executive Branch Code of Ethics, which states, in part:

KRS 11A.040 (7) provides:

No present or former public servant shall, within six (6) months following termination of his office or employment, accept employment, compensation, or other economic benefit from any person or business that contracts or does business with, or is regulated by, the state in matters in which he was directly involved during the last thirty-six (36) months of his tenure. This provision shall not prohibit an individual from returning to the same business, firm, occupation, or profession in which he was involved prior to taking office or beginning his term of employment, or for which he received, prior to his state employment, a professional degree or license, provided that, for a period of six (6) months, he personally refrains from working on any matter in which he was directly involved during the last thirty-six (36) months of his tenure in state government. This subsection shall not prohibit the performance of ministerial functions, including but not limited to filing tax returns, filing applications for permits or licenses, or filing incorporation papers, nor shall it prohibit the former officer or public servant from receiving public funds disbursed through entitlement programs.

KRS 11A.040 (9) states:

A former public servant shall not represent a person or business before a state agency in a matter in which the former public servant was directly involved during the last thirty-six (36) months of his tenure, for a period of one (1) year after the latter of:

- a) The date of leaving office or termination of employment; or
- b) The date the term of office expires to which the public servant was elected.

This law is intended to promote public confidence in the integrity of state government and to declare as public policy the idea that state employees should view their work as a public trust and not as a way to obtain private benefits.

If you have worked for the executive branch of state government within the past six months, you may be subject to the law's prohibitions. The law's applicability may be different if you hold elected office or are contemplating representation of another before a state agency.

Also, if you are affiliated with a firm which does business with the state and which employs former state executive-branch employees, you should be aware that the law may apply to them.

In case of doubt, the law permits you to request an advisory opinion from the Executive Branch Ethics Commission, 3 Fountain Place, Frankfort, Kentucky 40601; telephone (502) 564-7954.

Revised: January 27, 2017

Kentucky Equal Employment Opportunity Act of 1978

The requirements of the Kentucky Equal Employment Opportunity Act of 1978 (KRS 45.560-45.640) shall apply to this Contract. The apparent low Bidder will be required to submit EEO forms to the Division of Construction Procurement, which will then forward to the Finance and Administration Cabinet for review and approval. No award will become effective until all forms are submitted and EEO/CC has certified compliance. The required EEO forms are as follows:

- EEO-1: Employer Information Report
- Affidavit of Intent to Comply
- Employee Data Sheet
- Subcontractor Report

These forms are available on the Finance and Administration's web page under ***Vendor Information, Standard Attachments and General Terms*** at the following address:
<https://www.eProcurement.ky.gov>.

Bidders currently certified as being in compliance by the Finance and Administration Cabinet may submit a copy of their approval letter in lieu of the referenced EEO forms.

For questions or assistance please contact the Finance and Administration Cabinet by email at **finance.contractcompliance@ky.gov** or by phone at 502-564-2874.

EMPLOYEE RIGHTS UNDER THE FAIR LABOR STANDARDS ACT

THE UNITED STATES DEPARTMENT OF LABOR WAGE AND HOUR DIVISION

FEDERAL MINIMUM WAGE

\$7.25

 PER HOUR

BEGINNING JULY 24, 2009

OVERTIME PAY At least 1½ times your regular rate of pay for all hours worked over 40 in a workweek.

CHILD LABOR An employee must be at least **16** years old to work in most non-farm jobs and at least **18** to work in non-farm jobs declared hazardous by the Secretary of Labor.

Youths **14** and **15** years old may work outside school hours in various non-manufacturing, non-mining, non-hazardous jobs under the following conditions:

No more than

- **3** hours on a school day or **18** hours in a school week;
- **8** hours on a non-school day or **40** hours in a non-school week.

Also, work may not begin before **7 a.m.** or end after **7 p.m.**, except from June 1 through Labor Day, when evening hours are extended to **9 p.m.** Different rules apply in agricultural employment.

TIP CREDIT Employers of “tipped employees” must pay a cash wage of at least \$2.13 per hour if they claim a tip credit against their minimum wage obligation. If an employee’s tips combined with the employer’s cash wage of at least \$2.13 per hour do not equal the minimum hourly wage, the employer must make up the difference. Certain other conditions must also be met.

ENFORCEMENT The Department of Labor may recover back wages either administratively or through court action, for the employees that have been underpaid in violation of the law. Violations may result in civil or criminal action.

Employers may be assessed civil money penalties of up to \$1,100 for each willful or repeated violation of the minimum wage or overtime pay provisions of the law and up to \$11,000 for each employee who is the subject of a violation of the Act’s child labor provisions. In addition, a civil money penalty of up to \$50,000 may be assessed for each child labor violation that causes the death or serious injury of any minor employee, and such assessments may be doubled, up to \$100,000, when the violations are determined to be willful or repeated. The law also prohibits discriminating against or discharging workers who file a complaint or participate in any proceeding under the Act.

ADDITIONAL INFORMATION

- Certain occupations and establishments are exempt from the minimum wage and/or overtime pay provisions.
- Special provisions apply to workers in American Samoa and the Commonwealth of the Northern Mariana Islands.
- Some state laws provide greater employee protections; employers must comply with both.
- The law requires employers to display this poster where employees can readily see it.
- Employees under 20 years of age may be paid \$4.25 per hour during their first 90 consecutive calendar days of employment with an employer.
- Certain full-time students, student learners, apprentices, and workers with disabilities may be paid less than the minimum wage under special certificates issued by the Department of Labor.

For additional information:



1-866-4-USWAGE

(1-866-487-9243)

TTY: 1-877-889-5627



WWW.WAGEHOUR.DOL.GOV

PART IV
INSURANCE

INSURANCE

The Contractor shall procure and maintain the following insurance in addition to the insurance required by law:

- 1) Commercial General Liability-Occurrence form – not less than \$2,000,000 General aggregate, \$2,000,000 Products & Completed Aggregate, \$1,000,000 Personal & Advertising, \$1,000,000 each occurrence.
- 2) Automobile Liability- \$1,000,000 per accident
- 3) Employers Liability:
 - a) \$100,000 Each Accident Bodily Injury
 - b) \$500,000 Policy limit Bodily Injury by Disease
 - c) \$100,000 Each Employee Bodily Injury by Disease
- 4) The insurance required above must be evidenced by a Certificate of Insurance and this Certificate of Insurance must contain one of the following statements:
 - a) "policy contains no deductible clauses."
 - b) "policy contains _____ (amount) deductible property damage clause but company will pay claim and collect the deductible from the insured."
- 5) **KENTUCKY WORKMEN'S COMPENSATION INSURANCE.** The contractor shall furnish evidence of coverage of all his employees or give evidence of self-insurance by submitting a copy of a certificate issued by the Workmen's Compensation Board.

The cost of insurance is incidental to all contract items. All subcontractors must meet the same minimum insurance requirements.

PART V
BID ITEMS

PROPOSAL BID ITEMS

185007

Page 1 of 2

Report Date 9/25/18

Section: 0001 - PAVING

LINE	BID CODE	ALT	DESCRIPTION	QUANTITY	UNIT	UNIT PRIC	FP	AMOUNT
0010	00003		CRUSHED STONE BASE	68.00	TON		\$	
0020	00212		CL2 ASPH BASE 1.00D PG64-22	94.00	TON		\$	
0030	00307		CL2 ASPH SURF 0.38B PG64-22	22.00	TON		\$	
0040	06540		PAVE STRIPING-THERMO-4 IN W	178.00	LF		\$	
0050	06541		PAVE STRIPING-THERMO-4 IN Y	178.00	LF		\$	

Section: 0002 - ROADWAY

LINE	BID CODE	ALT	DESCRIPTION	QUANTITY	UNIT	UNIT PRIC	FP	AMOUNT
0060	02460		REMOVE TREES OR STUMPS	6.00	EACH		\$	
0070	05990		SODDING	88.00	SQYD		\$	
0080	21415ND		EROSION CONTROL	1.00	LS		\$	

Section: 0003 - BRIDGE - MID FORK OF BEARGRASS CREEK

LINE	BID CODE	ALT	DESCRIPTION	QUANTITY	UNIT	UNIT PRIC	FP	AMOUNT
0090	02014		BARRICADE-TYPE III	8.00	EACH		\$	
0100	02091		REMOVE PAVEMENT	292.00	SQYD		\$	
0110	02220		FLOWABLE FILL	44.00	CUYD		\$	
0120	02231		STRUCTURE GRANULAR BACKFILL	417.00	CUYD		\$	
0130	02562		TEMPORARY SIGNS	141.00	SQFT		\$	
0140	02650		MAINTAIN & CONTROL TRAFFIC	1.00	LS		\$	
0150	02671		PORTABLE CHANGEABLE MESSAGE SIGN	2.00	EACH		\$	
0160	02726		STAKING	1.00	LS		\$	
0170	03250		WATERPROOFING MEMBRANE	183.00	SQYD		\$	
0180	03302		REPAIR CONCRETE CURB	148.00	LF		\$	
0190	08004		STONE MASONRY VENEER (REPLACE STONE IN KIND)	637.00	SQFT		\$	
0200	22146EN		CONCRETE PATCHING REPAIR (MASONRY PATCHING REPAIR)	44.00	SQFT		\$	
0210	23378EC		CONCRETE SEALING	2,869.00	SQFT		\$	
0220	23428EC		CONCRETE PATCHING REPAIR	351.00	CUFT		\$	
0230	24492EC		CLEAN (EXISTING MASONRY)	1.00	LS		\$	
0240	24731EC		REMOVE AND RESET (DECORATIVE RAILING, 178-LF)	178.00	EACH		\$	
0250	24731EC		REMOVE AND RESET (DECORATIVE URNS: REPLACE IF MISSING)	4.00	EACH		\$	
0260	24823EC		DUTCHMAN REPAIR	24.00	SQFT		\$	
0270	24824EC		MASONRY CRACK REPAIR	23.00	LF		\$	
0280	24827EC		REPOINTING	400.00	LF		\$	

Section: 0004 - DEMOBILIZATION &/OR MOBILIZATION

LINE	BID CODE	ALT	DESCRIPTION	QUANTITY	UNIT	UNIT PRIC	FP	AMOUNT
------	----------	-----	-------------	----------	------	-----------	----	--------

185007

PROPOSAL BID ITEMS

Page 2 of 2

Report Date 9/25/18

LINE	BID CODE	ALT	DESCRIPTION	QUANTITY	UNIT	UNIT PRIC	FP	AMOUNT
0290	02569		DEMOBILIZATION	1.00	LS		\$	